



**FIBER**

**H-2/4 HDMI/SDI-ATSC-IP**

**Encoder Modulator**

# **A Note From Thor About This Manual**

## **Intended Audience**

This user manual has been written to help people who have to use, integrate and to install the product. Some chapters require some prerequisite knowledge in electronics and especially in broadcast technologies and standards.

## **Disclaimer**

No part of this document may be reproduced in any form without the written permission of Thor Broadcast.

The contents of this document are subject to revision without notice due to continued progress in methodology, design and manufacturing. Thor shall have no liability for any error or damage of any kind resulting from the use of this document.

## **Copy Warning**

This document includes some confidential information. Its usage is limited to the owners of the product that it is relevant to. It cannot be copied, modified, or translated in another language without prior written authorization from Thor Broadcast.

# Directory

<b>CHAPTER 1 INTRODUCTION .....</b>	<b>1</b>
1.1 PRODUCT OVERVIEW .....	1
1.2 KEY FEATURES .....	1
1.3 SPECIFICATIONS .....	2
1.4 SCHEMATIC OVERVIEW .....	3
1.5 PRINCIPLE CHART .....	3
1.6 TYPICAL APPLICATION OF 4 * ATSC CARRIER OUTPUTS .....	3
1.7 APPEARANCE AND DESCRIPTION .....	4
<b>CHAPTER 2 INSTALLATION GUIDE .....</b>	<b>6</b>
2.1 GENERAL PRECAUTIONS .....	6
2.2 POWER PRECAUTIONS .....	<b>ERROR! BOOKMARK NOT DEFINED.</b>
2.3 DEVICE'S INSTALLATION FLOW CHART ILLUSTRATED AS FOLLOWING .....	6
2.4 ENVIRONMENT REQUIREMENT .....	6
2.5 GROUNDING REQUIREMENT .....	7
<b>CHAPTER 3 OPERATION .....</b>	<b>7</b>
3.1 LCD MENUS .....	8
3.2 INITIAL STATUS .....	9
3.3 GENERAL SETTINGS FOR MAIN MENU .....	10
<b>CHAPTER 4 WEB NMS OPERATION .....</b>	<b>17</b>
4.1 LOGIN .....	<b>ERROR! BOOKMARK NOT DEFINED.</b>
4.2 OPERATION .....	18
<b>CHAPTER 5 TROUBLESHOOTING .....</b>	<b>30</b>
<b>CHAPTER 6 APPLICATION .....</b>	<b>30</b>
<b>CHAPTER 7 PACKING LIST .....</b>	<b>33</b>



# Chapter 1 Introduction

## 1.1 Product Overview

The Thor H-4HDMI-ATSC-IP encoder is a powerful new all-in-one device which integrates encoding (MPEG-2 HD, MPEG-4/AVC H.264) and modulating ATSC to convert V/A signals into RF output. It comes equipped with 4 HDMI channels input and 1 ASI input and output with 2 ASI ports and 1 UDP IP port.

The signal source could be injected from satellite receivers, closed-circuit television cameras, Blu-ray players, and antennas. Its output signals are to be received by TVs, STB with corresponding standard of ATSC.

With its various inputs available, our encoder modulator are widely used in public places such as the mall, market hall, theatre, hotels, resorts, and etc for advertising, monitoring, training and educating in company's, schools, campuses, hospital.

## 1.2 Key Features

- **MPEG2 HD/MPEG4 HD video encoding**
- **Up to 1920\*1080@50P/60P supported (MPEG4 HD)**  
Up to 1920\*1080@50I/60I supported (MPEG2 HD)
- **4\* HDMI in, 1\*ASI in**
- **Simultaneously encoding each channel at more than 10Mbps**
- **4\* ATSC RF out (4 carriers combined output)**
- **Supports IP (MPTS) output**
- **Excellent modulation quality MER≥42dB**
- **RF Frequency range 30Mhz~960Mhz**
- **LCD display, Remote control and firmware**
- **Web NMS management; Updates via web**
- **Lowest cost per channel --- breakthrough price**

## 1.3 Specifications

### Encoding Section

#### Video

Encoding	MPEG2 HD/MPEG4 HD
Input	HDMI*4
Resolution	1920*1080_60P, 1920*1080_50P, (-for MPEG4/H.264) 1920*1080_60i, 1920*1080_50i, 1280*720_60p, 1280*720_50P 720*480_60i, 720*576_50i

#### Audio

encoding	MPEG1 Layer II, (MPEG2-AAC, MPEG4-AAC available )
Sample rate	48KHz
Bit rate	64kbps, 96kbps,128kbps, 192kbps, 256kbps, 320kbps

### ATSC Modulator Section

Standard	ATSC A/53
Constellation	8 VSB
RF Output Level	26~-10dbm (81~97dbμV), 0.1db step
MER	≥42dB
RF frequency	30~960MHz, 1KHz step

### System

Local interface	LCD + control buttons
Remote management	Web NMS
output	2 ASI out (BNC type); 1 IP out (RJ45, 100M)
NMS interface	RJ45, 100M
Language	English

### General

Power supply	AC 100V~240V
Dimensions	482*400*44mm
Weight	5 kgs
Operation temperature	0~45°C

### 1.4 Schematic Overview

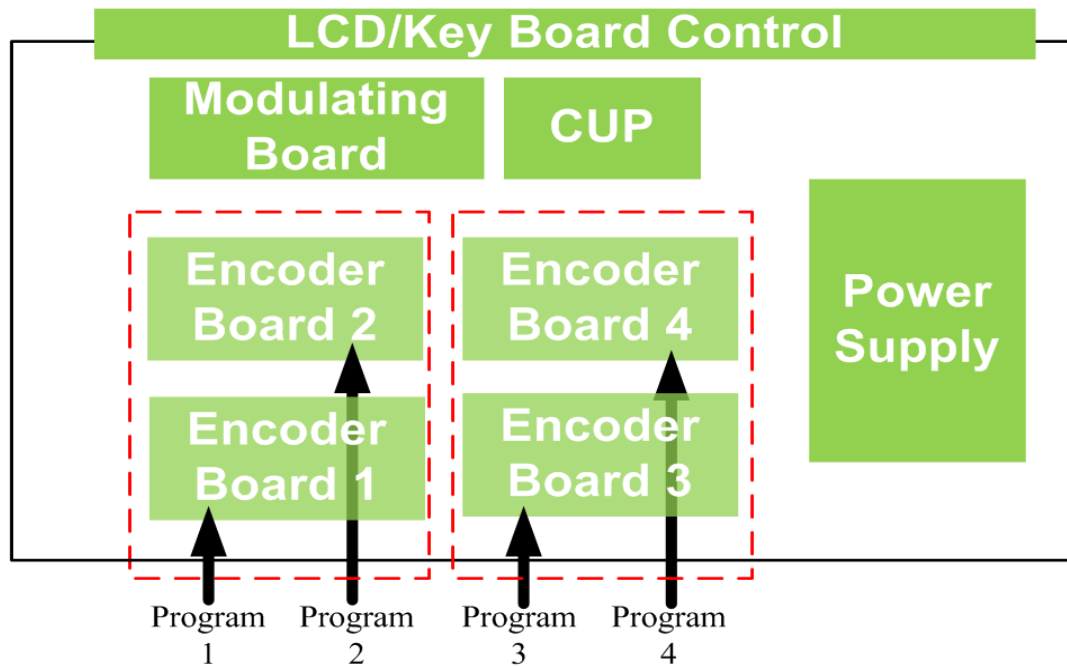

### 1.5 Principle Chart

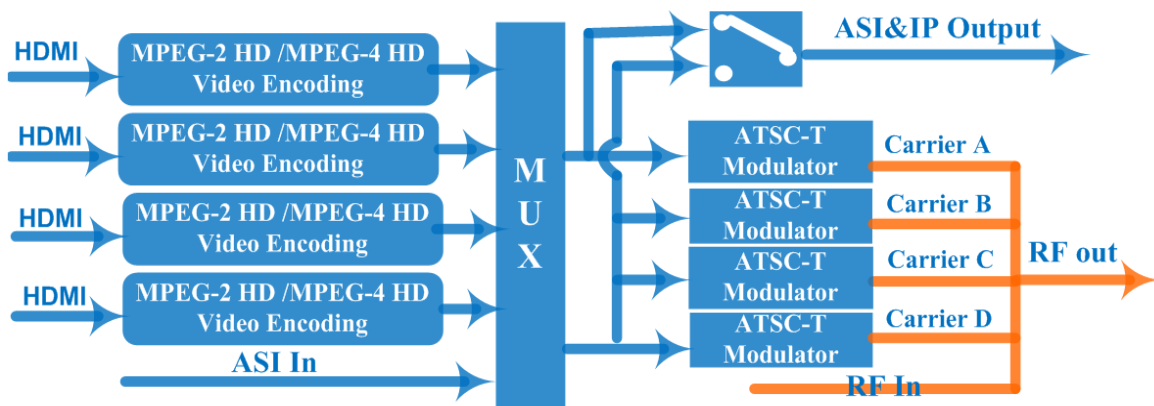

### 1.6 Typical Application of 4 \* ATSC Carrier Outputs

To maximize the potential of our encoder for ATSC we have been able to boost the maximum possible bit-rate bandwidth up to 76Mbps (19\*4), which makes it reliably carry 4 channel HD programs output simultaneously. This power has helped stem the source encoding and modulation to any amount of TV's at 1080i quality in MPEG2,

and 1080p quality resolution on MPEG4. Previously the maximum bitrate was only 11Mbps, this powerful unit will now help drive any digital programming at the highest resolution rate allowed on the market.

Below brief chart will help to more clearly illustrate the working principle.

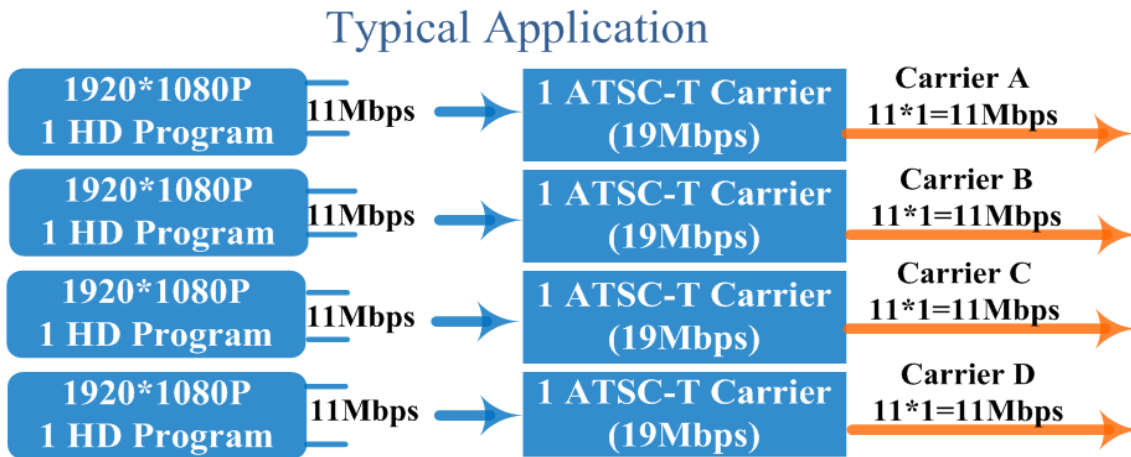

## 1.7 Appearance and Description

Front Panel Illustration

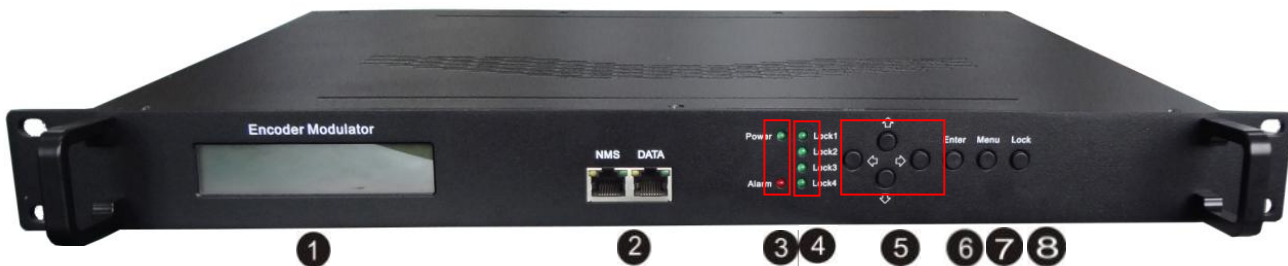

- ① LCD window: LCD display
- ② NMS & DATA ports
- ③ Power and Alarm Indicators
- ④ Lock Indicators
- ⑤ Up and down, left and right button
- ⑥ Enter button: for confirm
- ⑦ Menu button: for back step
- ⑧ Lock button: press to lock set



Rear Panel Illustration



- ① HDMI Module 1: HDMI input port 1&2
- ② HDMI Module 2: HDMI input port 3&4
- ③ RF in port (for combiner use)
- ④ RF out port
- ⑤ ASI input port
- ⑥ ASI output ports
- ⑦ Switch
- ⑧ Power supply slot
- ⑨ Grounding

## Chapter 2 Installation Guide

### 2.1 General Precautions

- ✓ Must be operated and maintained in an area free of dust and debris.
- ✓ The cover should be securely fastened, do not open the cover of the chassis when the power is on. This will also void Thor’s manufacturer’s warranty.
- ✓ After installation, securely stow away all loose cables, external antenna, and others.

### 2.2 Power Precautions

- ✓ Be careful when connecting a power source to the device.
- ✓ Do not operate in wet or damp areas. Make sure the extension cable is in good condition
- ✓ Make sure the power switch is off before you start to install the device

### 2.3 Device’s Installation Flow Chart Illustrated as following

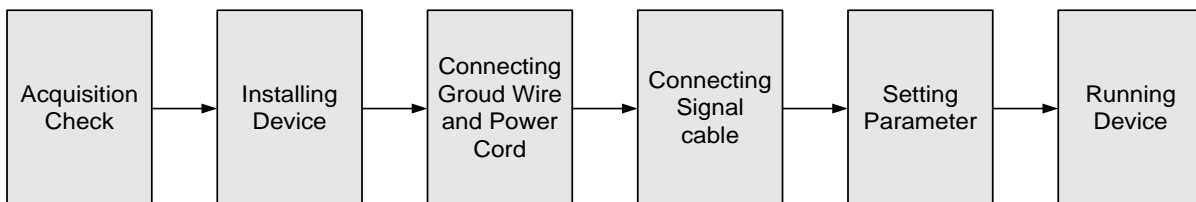

### 2.4 Environment Requirement

Item	Requirement
Rack Mount	When user installs machine on rack, the distance between 2 rows of machine frames should be 1.2~1.5m and the distance against wall should be no less than 0.8m.
Floor/ Table	Electric Isolation, Dust Free Volume resistivity of ground anti-static material: $1 \times 10^7 \sim 1 \times 10^{10} \Omega$ , Grounding current limiting resistance: $1 M\Omega$ (Floor bearing should be greater than $450 \text{Kg/m}^2$ )

Environment Temperature	5~40°C(sustainable ), 0~45°C(short time), installing HVAC is recommended
Relative Humidity	20%~80% sustainable 10%~90% short time
Pressure	86~105KPa
Door & Window	Installing rubber strip for sealing door-gaps and dual level glasses for window
Fire Protection	Fire alarm system and extinguisher
Power	Device power, HVAC and lighting should be independent to each other. Device power requires AC 110V±10%, 50/60Hz or AC 220V±10%, 50/60Hz. Please carefully check before running.

## 2.5 Grounding Requirement

- ✓ It is important to keep this device grounded to ensure all of the modules function correctly. Correctly grounding the device will also help prevent any electrical interference, lightning. Etc. Also it helps reject minor interference that may disrupt the devices ability to function smoothly. General rule of them, make sure the device is grounded when installing anywhere.
- ✓ Always use copper wire. When applied correctly the ground must be wrapped well to ensure maximum conduction so it can reduce any high frequencies. The copper ground wire should also be as short and thick as possible
- ✓ Installer must make sure that the two ends of the ground are well conducted and have appropriate anti-rust properties.
- ✓ It is prohibited to use any other device as part of the grounding electric circuit.
- ✓ The area of the conduction between the ground wire and device's frame should be no less than 25 m<sup>2</sup>.

# Chapter 3 Operation

## 3.1 LCD Menus

*An overview of the LCD menu tree:*

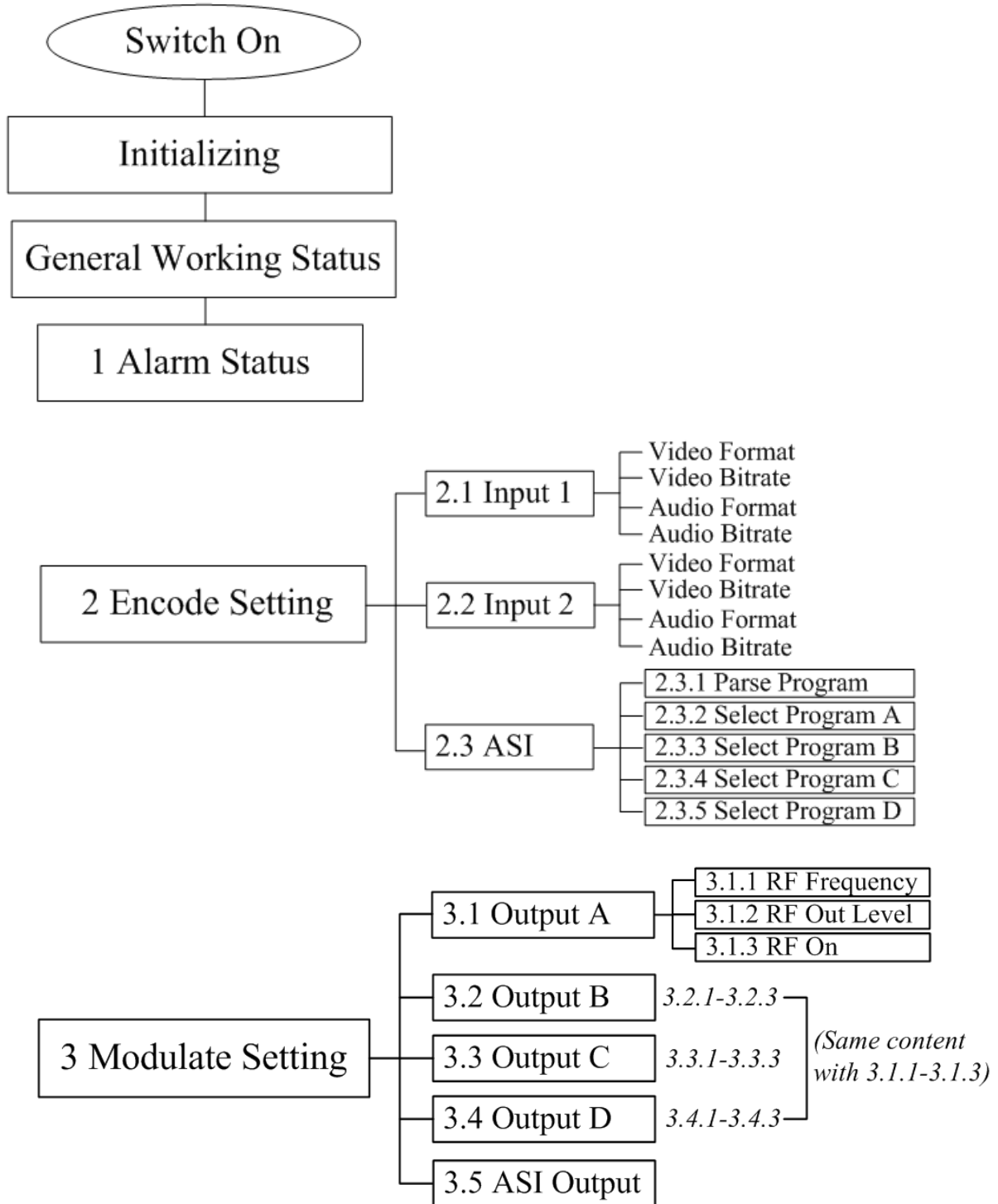

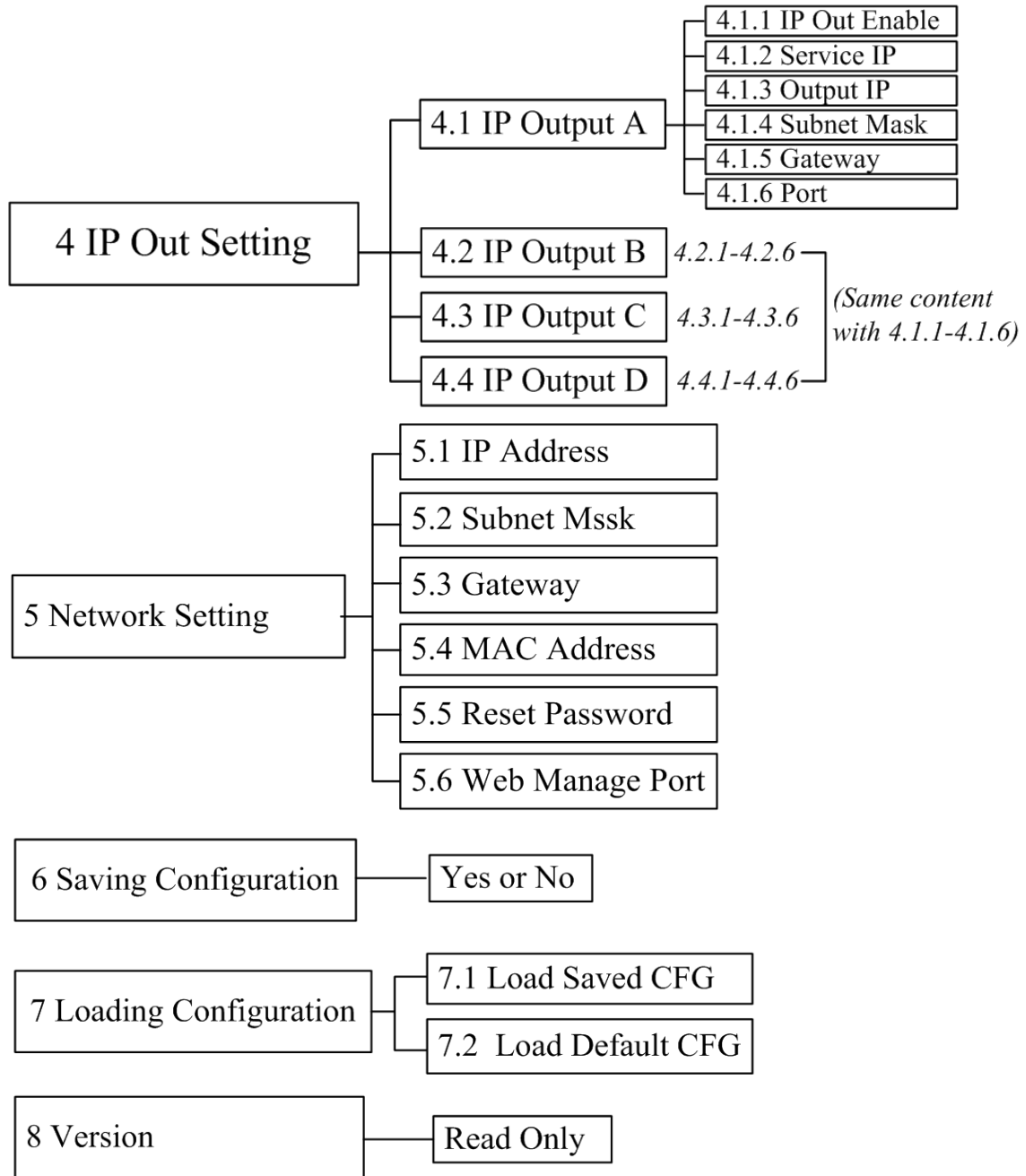

### 3.2 Initial Status

After powering on the device, it will take a few seconds to initialize the system

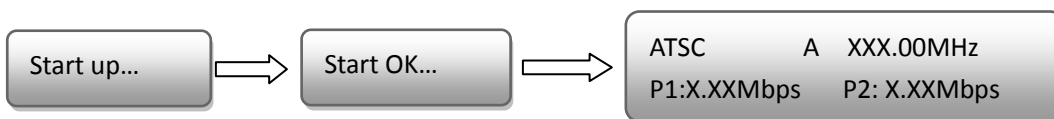

- **ATSC**: indicates the modulation standard of this device: ATSC.

- **A**: the symbol of different carrier output. “A”, “B”, “C”, and “D” alternate constantly with the following output frequency.
- **XXX.XX MHz** indicates the current output frequency (range: 30~960MHz) of its corresponding carrier output.
- **P1**: Program 1; **P2**: Program 2; **P3**: Program 3; **P4**: Program 4
- **X.XX Mbps**: indicates the encoding bit rate of each channel respectively.

### 3.3 General Settings for Main Menu

By pressing “Lock” key on the front panel, enter the main menu. The LCD will display the following pages:

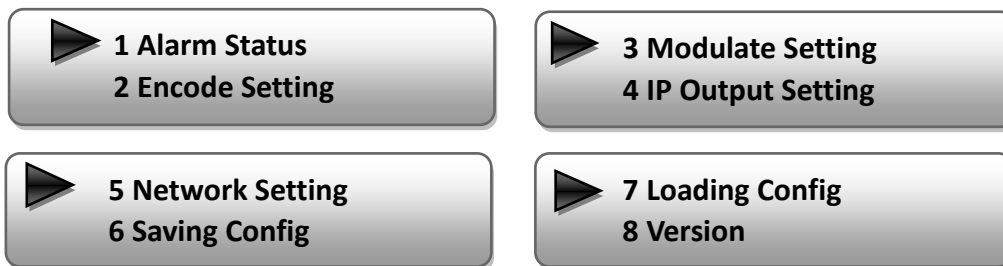

1) Press UP/DOWN buttons to specify menu items, and then press ENTER to enter the submenus as below:

#### 2) Alarm Status

The alarm indicator will turn on if there is no A/V signals inputting or outputting bit rate overflows. User then can enter this menu to check the error type.

#### 3) Encode Setting

Under this submenu, the LCD will show “2.1 Input 1”, “2.2 Input 2” and “2.3 ASI”.



Under submenus 2.1 or 2.2, user could set the video encoding format and bit rate, and set audio encoding bit rate and also read the audio encoding format of the program from the HDMI input.

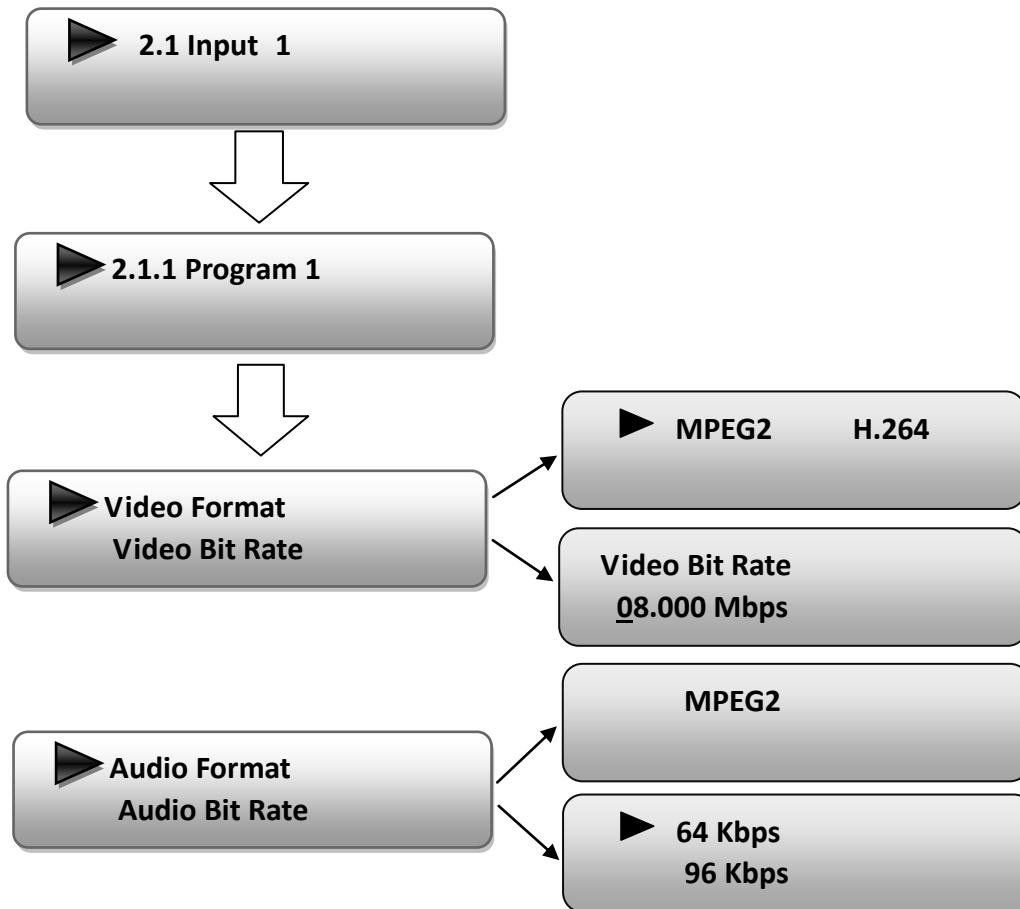

“Video Format”: the encoding module supports both MPEG2 and MPEG4 AVC/H.264 formats. Move the triangle mark with LEFT/RIGHT keys to specify the intended format and press ENTER to confirm.

“Video Bit Rate”: Move the underline with LEFT/RIGHT keys and modify the value of frequency (1-19Mbps) with UP/DOWN keys, and press ENTER key to save the settings.

“Low Delay”: Normal: disable the low delay mode. “Audio Format”: the encoding module supports MPEG2 audio format. This is a read-only interface for checking.

“Audio Bit rate” is for selecting bit rate for the audio. Move the triangle mark to specify the target bit rate and press ENTER to confirm.

Under submenu 2.3, you could parse the inputting programs and select the programs to output.

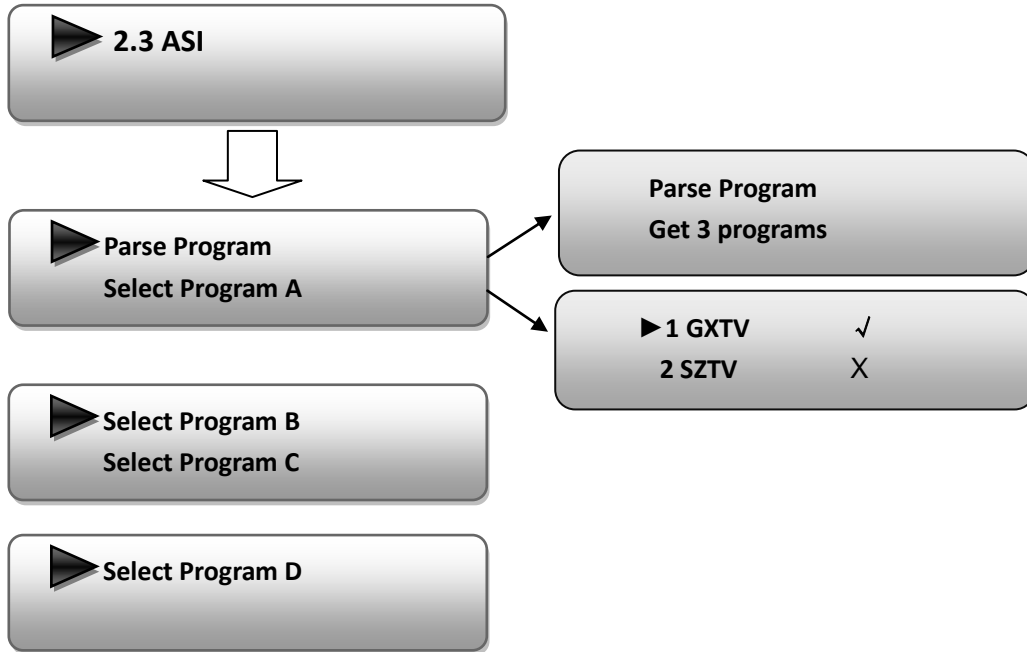

“Parse Program” is for checking the quantity of input programs from the ASI IN port.

“Select Program A” is for selecting programs from the ASI IN to output through Carrier A. Move the triangle mark to specify the program and press RIGHT/LEFT keys to shift the mark between “√” and “X”. (“√”: to output the corresponding program; “X”: not to output the corresponding program)

◆ **REMARK:** “Select Program B/C/D” shares the same explanation with “Select Program A”.

#### 4) Modulator Setting

When entering “Modulator Setting” submenu, below different parameters can be set and the LCD window would show these:

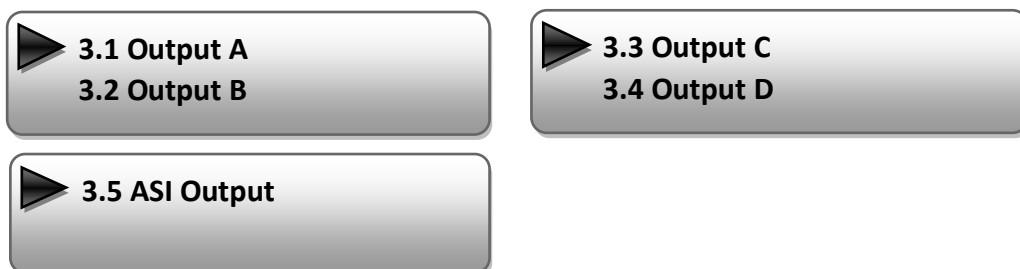

As the 4HDMI-ATSC unit comes with 4 carrier outputs, “3.1”-“3.4” represents the



“Carrier A”, “Carrier B”, “Carrier C”, and “Carrier D” respectively. Enter “3.1”/“3.2”/“3.4”/“3.4” to set the corresponding modulating parameters. Submenus (taking “3.1” as an example) are here:

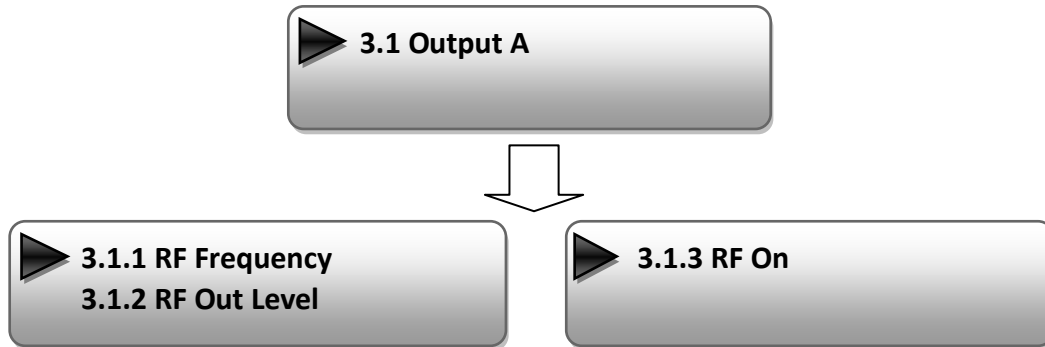

### ➤ RF Frequency

The RF output frequency range is from 30 to 960MHz with 1K stepping. After entering the RF frequency setting submenu, users can press LEFT, RIGHT, UP, and DOWN buttons to adjust the frequency and confirm by press ENTER button.



### ➤ RF out level

The RF attenuation range is from -30~-10dbm (81~97dbμV) with 0.1db step. After entering this setting submenu, user can shift UP/DOWN/LEFT/RIGHT key to set the output level and press ENTER to confirm.



### ➤ RF On

This interface allows you to enable the RF (carrier A) output or not.

**OFF:** to disable programs to output through carrier A.

**ON:** to enable programs to output through carrier A.

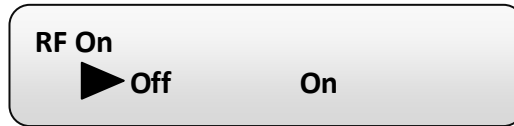

**NOTE:** The setting for “3.2”, “3.3”, and “3.4” are the same as “3.1” explained/shown above.

**ASI Output:**

The Thor 4-HDMI-ATSC-IP encoder & modulator has a quad-carrier output: Output A, B, C, and D.

**Output A:** the ASI output programs are same as carrier output A.

**Output B:** the ASI output programs are same as carrier output B.

**Output C:** the ASI output programs are same as carrier output C.

**Output D:** the ASI output programs are same as carrier output D.

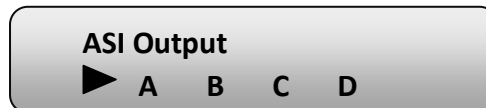

**5) IP Output Setting**

The Thor Encoder also has 4 MPTS IP output (Output A, B, C, and D), “4.1” to “4.4” are for the settings of the 4 MPTS IP outputs respectively. Submenus go as 4.1.1-4.1.6

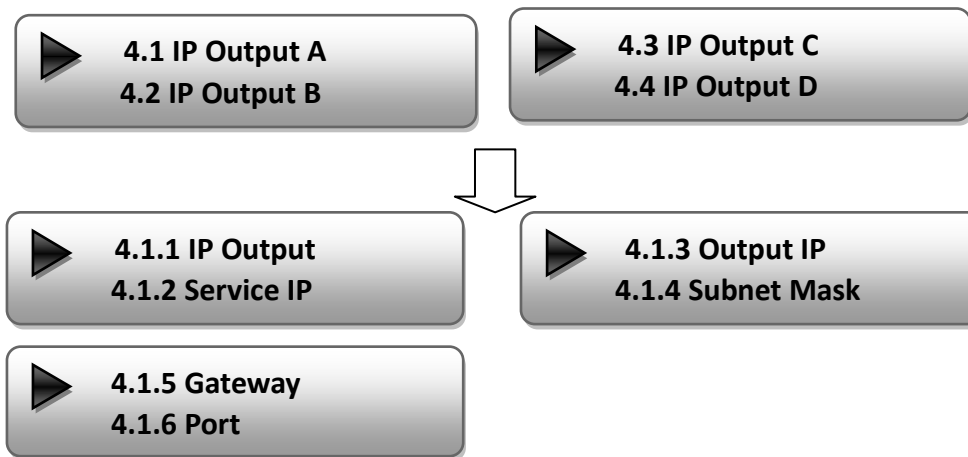

Enter 4.1.1 to decide whether to turn the IP port on or off, and enter to the rest menu items to set the corresponding parameters.

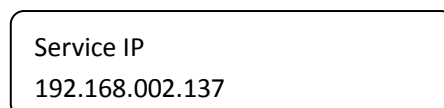

Output IP 224.002.002.002	Subnet mask 255.255.255.000
Gateway 192.168.002.000	Port <u>0</u> 1234

**NOTE: The sub-menus under “4.2”-“4.4” are the same as “4.1” explained above.**

**6) Network setting**

After you enter Network Setting, there are three submenus shows as the following LCD displays.

▶ 5.1 IP Address 5.2 Subnet Mask	▶ 5.3 Gateway 5.4 MAC Address
▶ 5.5 Reset Password 5.6 Web Manage Port	

Press “UP/DOWN” to choose this item and “ENTER” & “LEFT/RIGHT” to set the parameters.

IP Address <u>1</u> 92.168.000.136	Subnet Mask <u>2</u> 55.255.255.000
Gateway <u>1</u> 92.168.000.001	MAC Address f f f f f f f f f f f f f f f f f f
Reset Password? Yes ▶ NO	Web Manage Port <u>0</u> 0080

**NOTE: The MAC address is according to the factory setting, and it is unique.**

**7) Saving Configuration**

Enter Saving Configuration submenu for saving your current chosen settings. Choose yes and press ENTER to confirm.

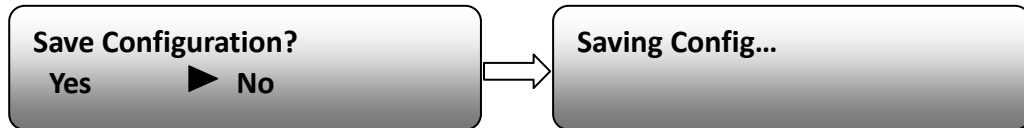

### 8) Loading Configuration

At this menu, user can press UP/DWON key to select and repress ENTER to confirm. User can restore the device into the last saved configuration by choosing "7.1" and restore the device into factory configuration by choosing "7.2" the display will show as below:

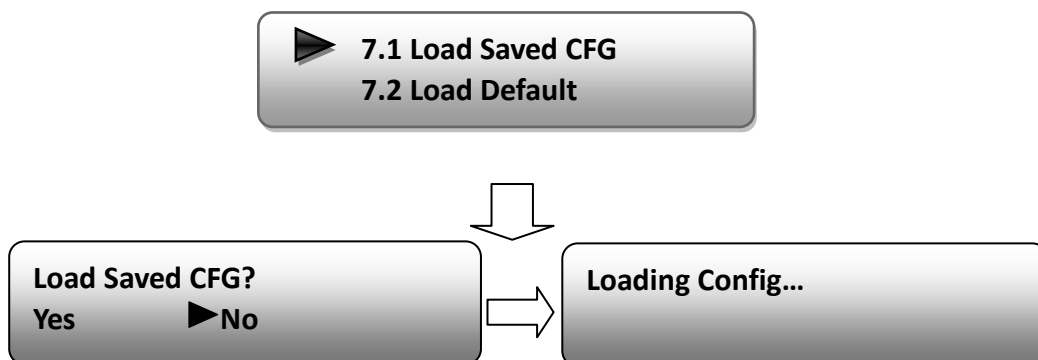

### 9) Version

User can check the software version and hardware version of this equipment under this submenu.



## Chapter 4 WEB NMS Operation

For setting configurations you can use the front panel; also you are able to control and set the configurations on any computer by connecting the device to the web NMS Port. You should ensure that the computer's IP address is different from the THOR 4-ADHD's IP address; otherwise, it would cause IP conflict.

### 4.1 login

The default IP of this device is 192.168.0.136. We can modify the IP through the front panel.

Connect the pc and the device with net cable, and use ping command to confirm they are on the same network segment.

E.G. the PC IP address is 192.168.99.252, we then change the device IP to 192.168.99.xxx (xxx can be 0 to 255 except 252 to avoid IP conflict).

Use any web browser to connect the device with the PC by inputting the Encoder & Modulator's IP address in the browser's address bar and press Enter.

It will display the Login interface as Figure-1. Input the Username and Password (Both the default Username and Password are "admin".) and then click "LOGIN" to start the device setting.

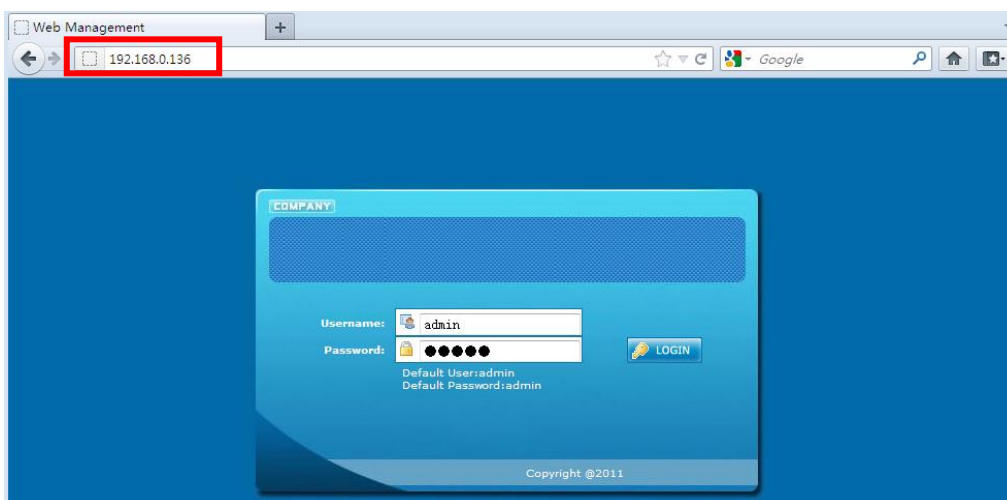

Figure-1

## 4.2 Operation

When we confirm the login, it displays the WELCOME interface as Figure-2.

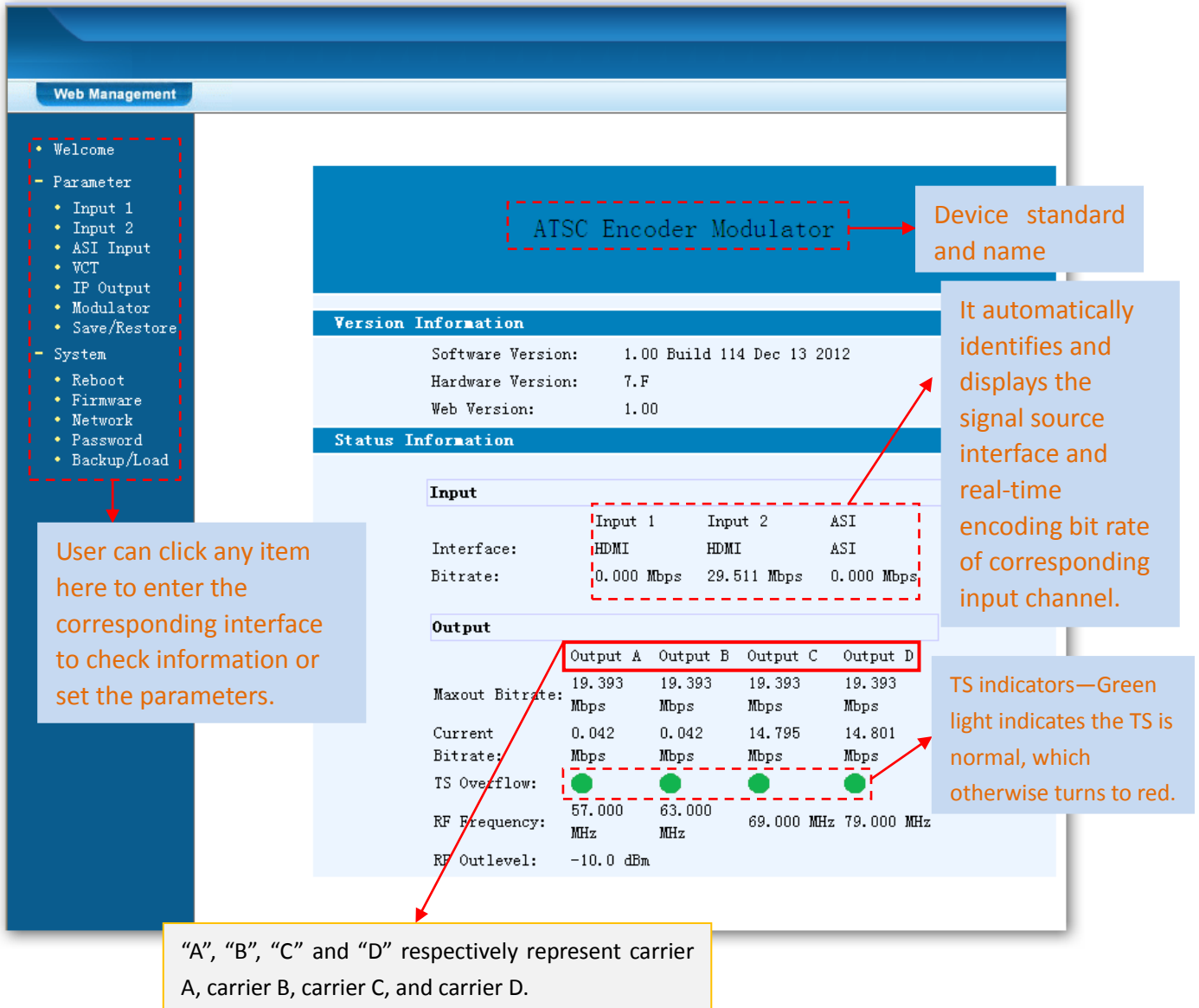

Figure-2

### Input

From the menu on left side of the webpage, clicking “Input 1”, it displays the information of the 2 programs from the 1<sup>st</sup> HDMI encoding slot as Figure-3.

This column is for setting the 1<sup>st</sup> HDMI IN program.

This column is for setting the 2<sup>ed</sup> HDMI IN program.

General Settings for the HDMI IN programs: User can edit any item listed as needed.

Encoding Status—Green light indicate it works normally, which otherwise turn to red.

Figure-3

### Enable or Disable the Carrier Output Function:

The 4 boxes respectively represent IP Channel A, B, C, and D. The related programs can output through the selected IP Channel(s). (It shows that the 1<sup>st</sup> program outputs through IP Channel C and the 2<sup>ed</sup> through IP Channel D). One program can also output through more than one IP Channels. (e.g.:    )

Refer to "1.4 Schematic Overview" for the relationship between the input interfaces and encoder boards.

Click the box to enable or disable the program output through channel A/B/C/D.

**Help** Further assistance if necessary

**Default** Click this button to apply the default setting of Input 1

**Apply** Click this button to apply the modified parameters.

## Input 2

Similarly, from the menu on left side of the webpage, click “Input 2” and it displays the information of the 2 programs from the 2<sup>ed</sup> HDMI encoding slot. (Figure-4)

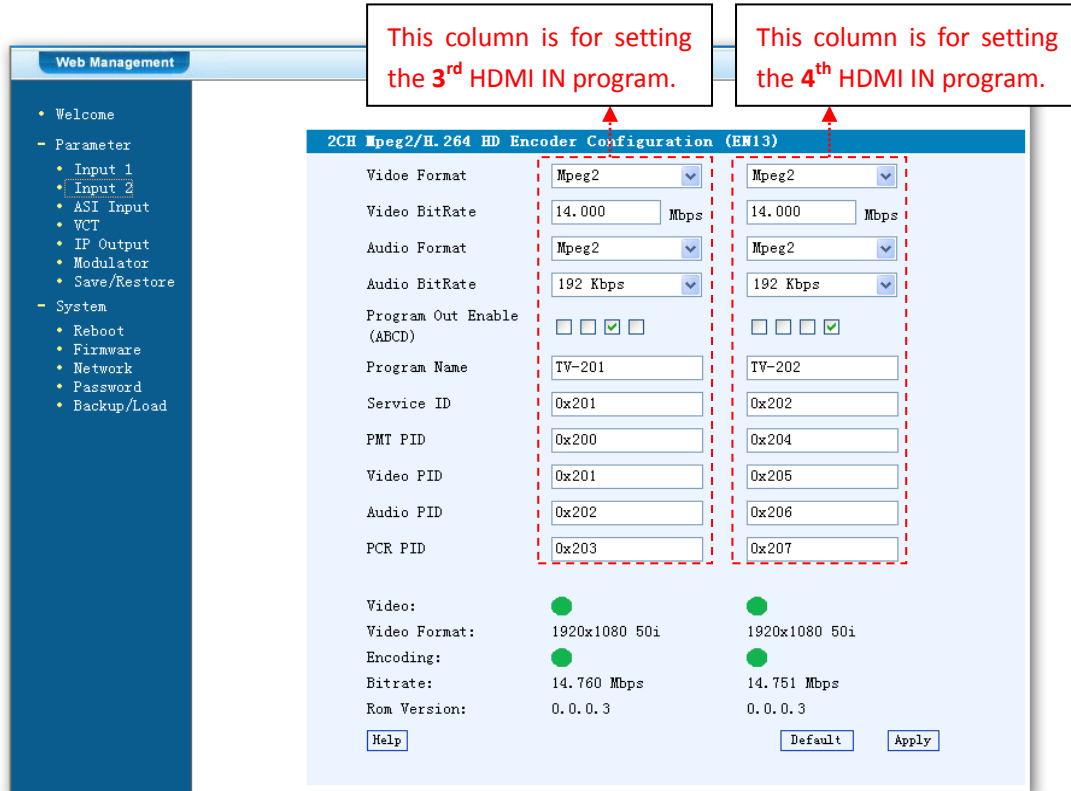

Figure-4

## ASI Input

Click “ASI Input”, it will display ASI input program information as Figure-5.

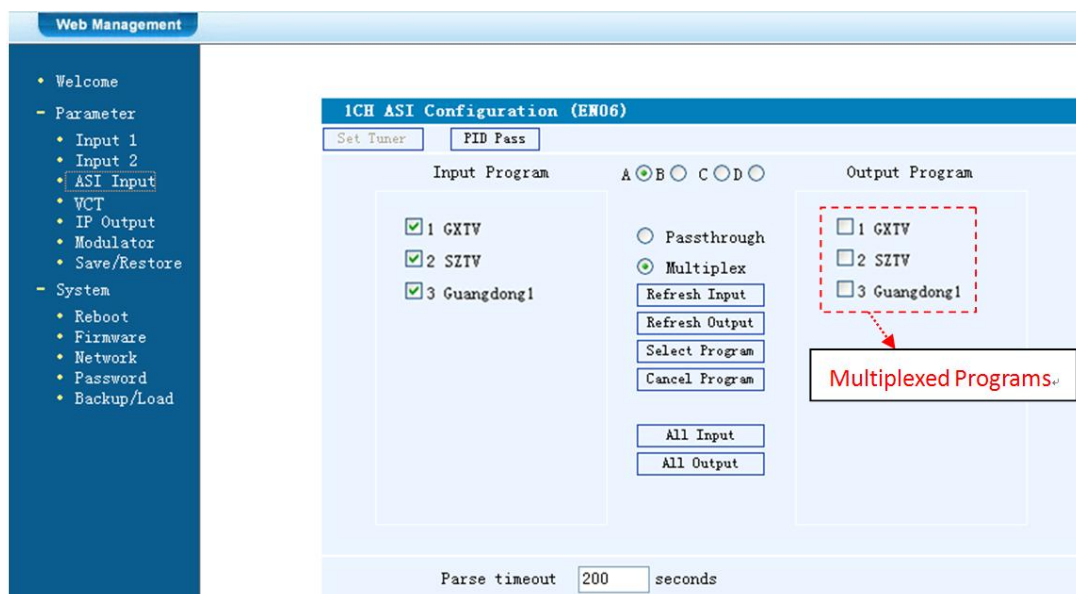



Figure-5

A  B  C  D  E The letters A to D represent the 4 carrier outputs. E represents the ASI output. Configure different program groups for each carrier output.

Passthrough If this item is selected, all the input programs will pass through without any elimination.

Multiplex Selecting this item to allow user select programs as required to output.

Click “Refresh Input” to refresh the input program list.

Click “Refresh Output” to refresh the output program list.

When user checks one input program with “√”, one can transfer the checked program to the right box to output.

Select the programs which we want to output or we can output all the programs.

Similarly, cancel the multiplexed programs from the right box.

&  to select all the input/output programs with one-time clicking.

Time limitation to parse the input programs

Click this button to trigger a dialog box as shown below, where to add the PIDs which need pass through.

In some occasions, there are some PIDs which won't belong to any program, such as EPG, NIT tables and so on which user just wants to pass them through the multiplexing module without changing anything. This is the main purpose of this function.



Click “Add”  to add more boxes for filling the Input & Output PIDs, then click “Apply” to confirm.

## VCT (Virtual Channel Table) Setting

Click “NIT” from the menu to trigger the screen as Figure-6. Then click “Add” from this screen to add the program descriptor in VCT.

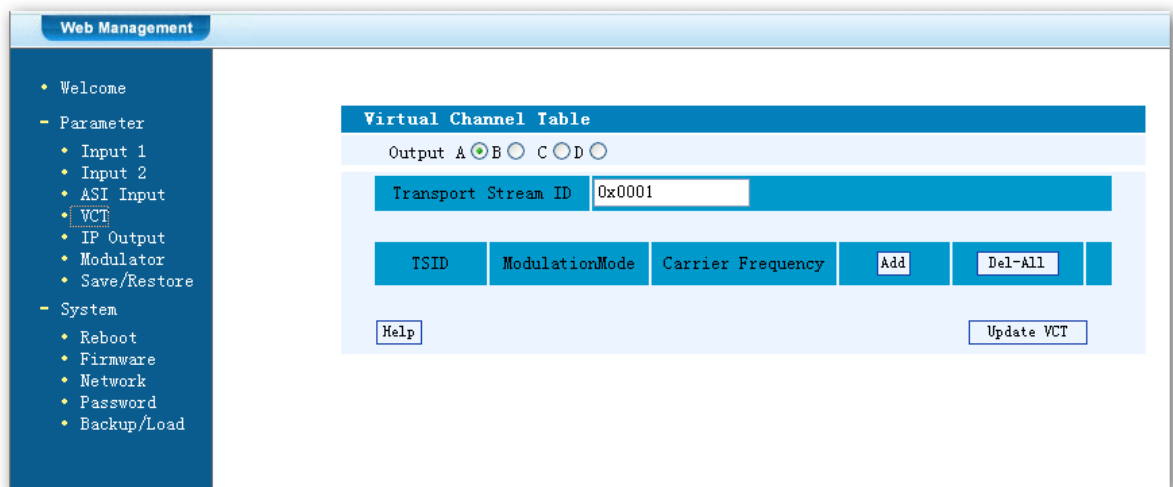

Figure-6

Output A  B  C  D  Select the carrier output channel for the inserted VCT.

Click “Add” from this page, it will display the screen as Figure-7 where it requires to add Channel TSID and configure other parameters for the programs.

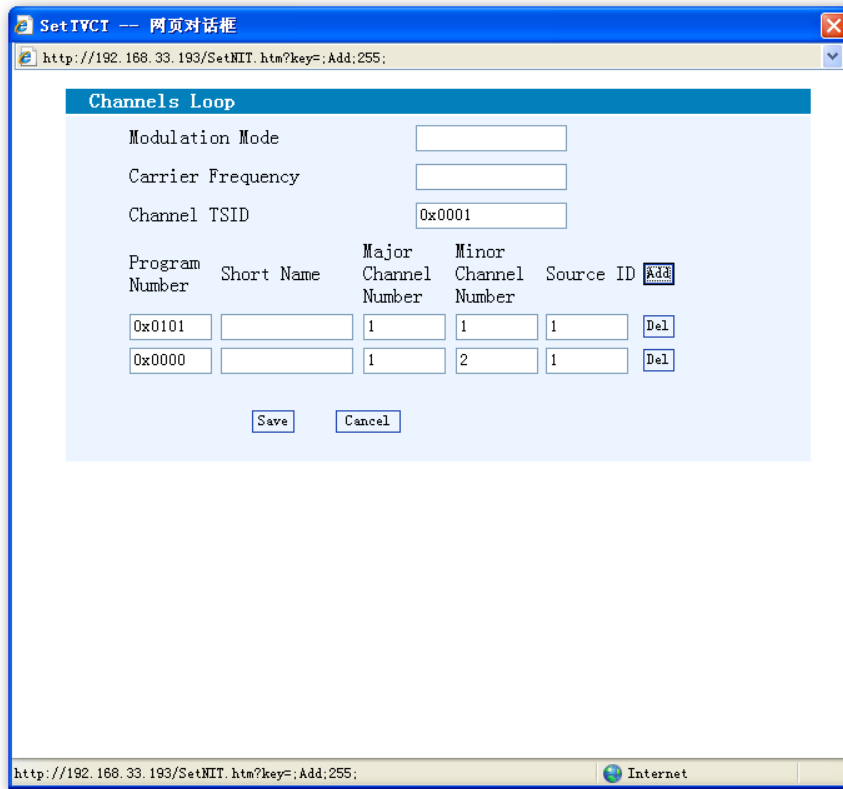

Figure-7

**Add** : Click “Add” to add boxes where to configure parameters in its respective fields. After setting all the data, users need to click “Save” **Save** to save the setting.

## IP Output

Click “IP Output” from the left menu, it will display the screen as Figure-8 where to configure the 4 IP SPTS Output.

After setting the parameters, click “Apply” to save the setting.

**Web Management**

- Welcome
- Parameter
  - Input 1
  - Input 2
  - ASI Input
  - VCT
  - IP Output**
  - Modulator
  - Save/Restore
- System
  - Reboot
  - Firmware
  - Network
  - Password
  - Backup/Load

**IP Output Configuration**

IP Output: If not set, the following parameters will be no use, the IP Output will not work.

Enable:

Service IP: The IP Output port address. The format is xxx.xxx.xxx.xxx (like as 192.168.2.137).

Output IP: The IP Output data receive address. The format is xxx.xxx.xxx.xxx (like as 224.2.2.2). After set the Output IP address, you must use the new address to receive IP Output data.

Subnet Mask: General is 255.255.255.0, it is must the same in a local area network.

Gateway: If the device is in different net segment, you must set the gateway.

Port: The UDP protocol port (like as 8001), you should use Output IP and new port to receive IP Output data (like as udp://224.2.2.2:8001).

Output IP A: 224.2.2.2      Port: 1234

Output IP B: 224.2.2.2      Port: 1235

Output IP C: 224.2.2.2      Port: 1236

Output IP D: 224.2.2.2      Port: 1237

Service IP: 192.168.2.137

Subnet Mask: 255.255.255.0

Gateway: 192.168.2.0

Default      Apply

*This device has MPTS IP outputs. The 4 boxes represent respectively IP Channels 1/2/3/4. Click the related box(es) to enable the corresponding channel(s) to output programs.*

*To configure the output IP address and ports for the 4 IP Channels respectively.*

Figure-8

## Modulator Setting

Enter in “Modulator” and it will display the Modulator Configuration screen as Figure-9 where can set modulation parameters.

**RF On** –To enable the RF (carrier A/B/C/D) output or not.

**RF Frequency A/B/C/D**– to set the RF frequency for the 4 carriers

**RF Out level** –to set the RF output level

**ASI Output**– To select carrier output channel for ASI output (**Output A:** The ASI output programs are same as carrier A; **Output B:** The ASI output programs are same as carrier B; and the like.)

After setting all the parameters, click “Apply” **Apply** to save the Modulator Configuration.

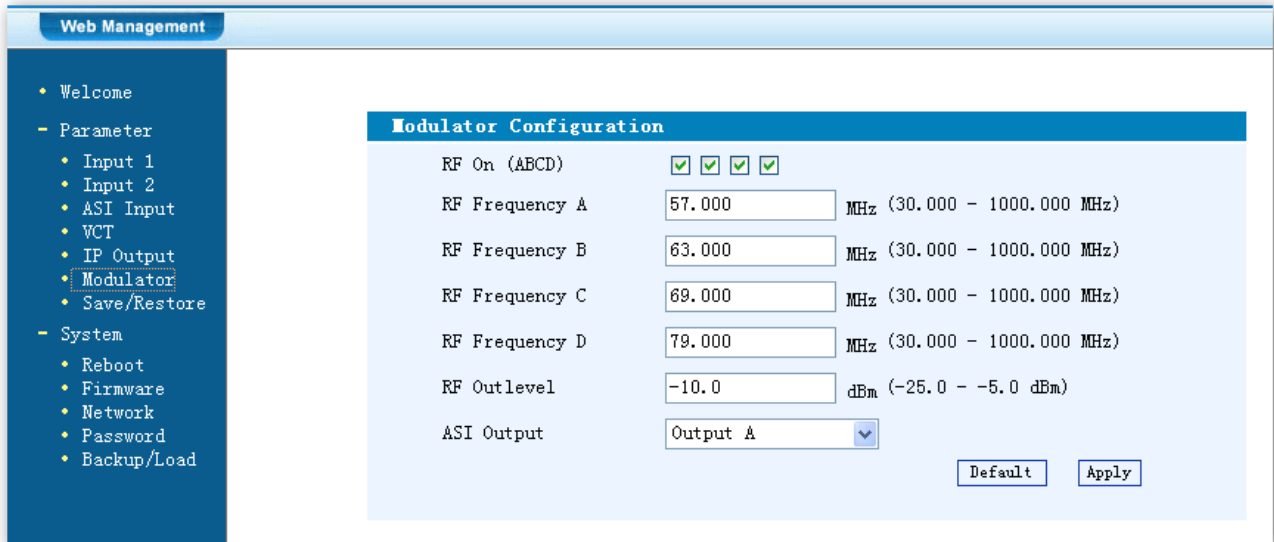

Figure-9

## Save/Restore

Clicking “Save/Restore” from the menu, it will display the screen as Figure-10 where can save the configuration permanently to the device. Click “Save Configuration”, for store the data permanently to the device.

By using “Restore Configuration” user can restore the latest saved configuration to the device.

By using “Factory Set” user can import the default factory configuration.

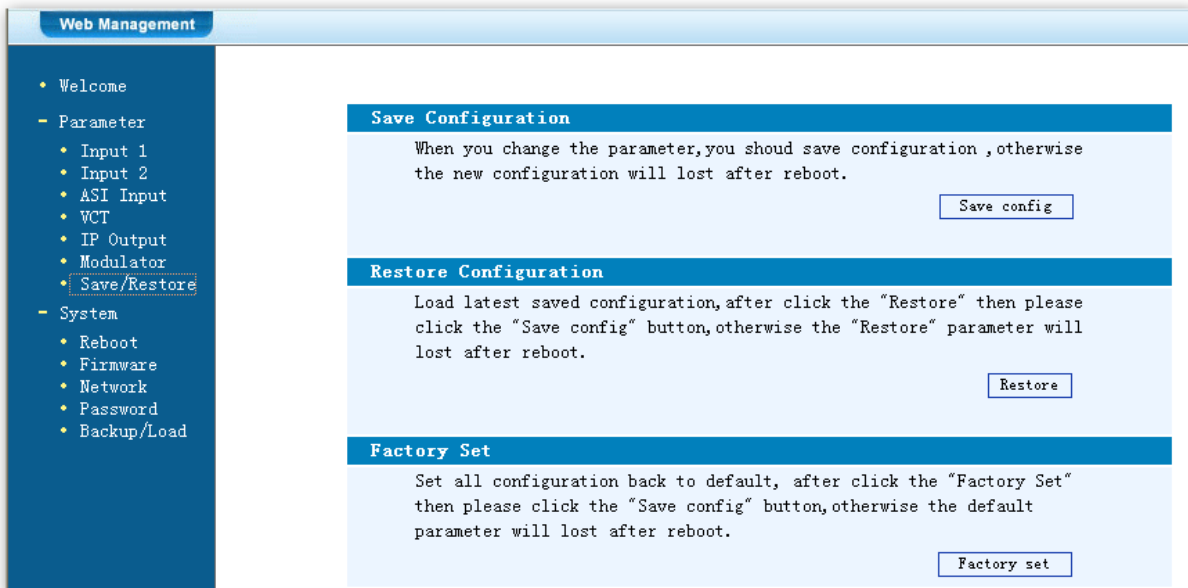

Figure-10

## Restart the Device

Click “Reboot” from the menu, the screen will display as Figure-11. Here when clicking “Reboot” box, it will restart the device automatically.

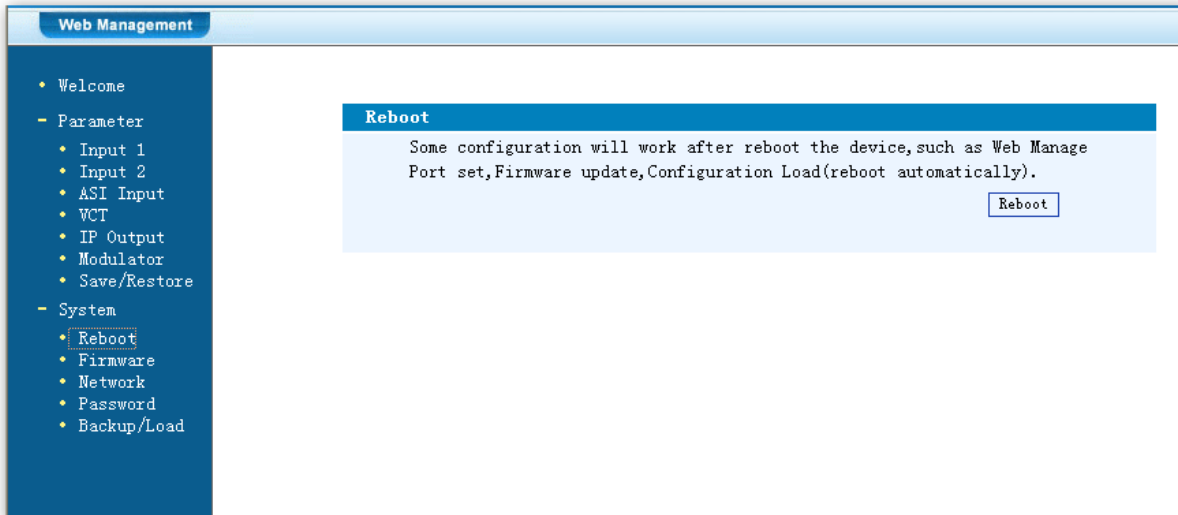

Figure-11

## Update the Device

Click “Firmware” from the menu it will display the screen as Figure-12. Here user can update the device by using the update file.

Click “Browse” to find the path of the device update file for this device then click “Update” to update the device.

After updating the device, user needs to restart the device by using Reboot option.

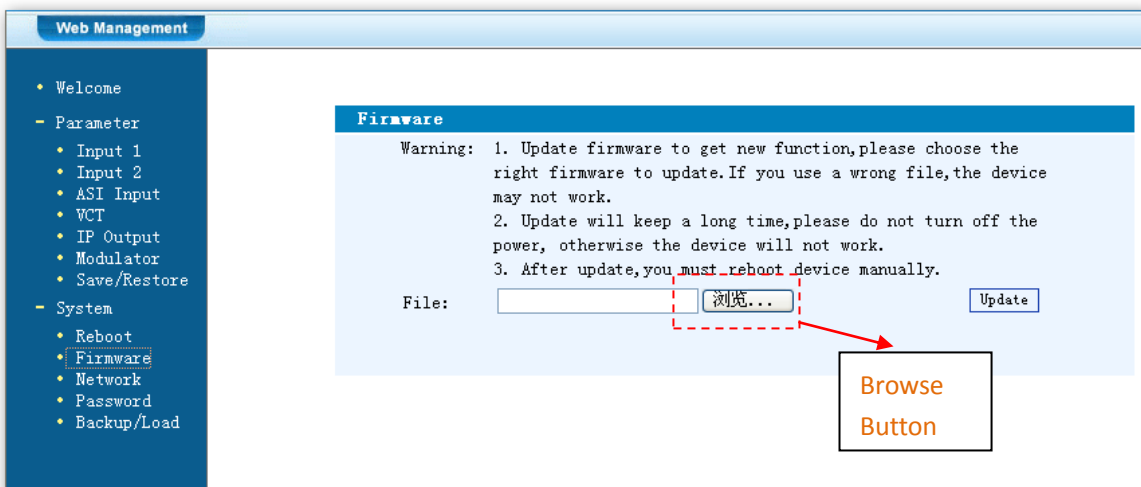

Figure-12

## Network

When you click “Network”, it will display the screen as Figure-13. It displays the network information of the device. Here change the device network configuration as needed.

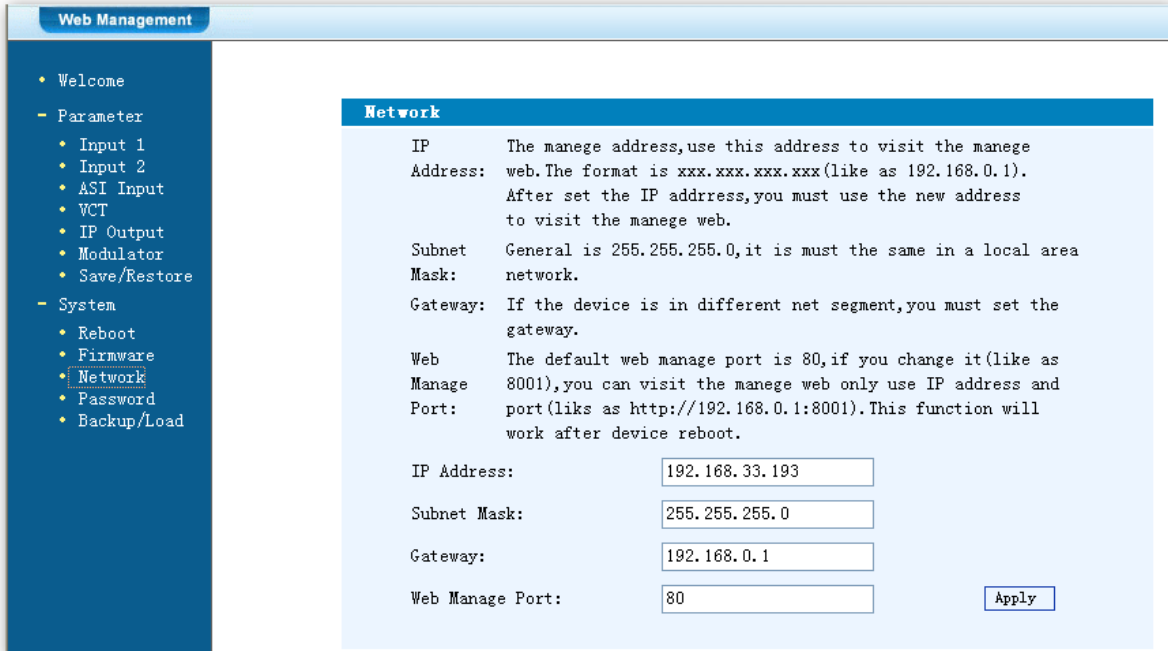

Figure-13

## Password

When user clicks “Password”, it will display the password screen as Figure-14. Here change the Username and Password for login to the device.

After putting the current and new Username and Password, click “Apply” to save the configuration.

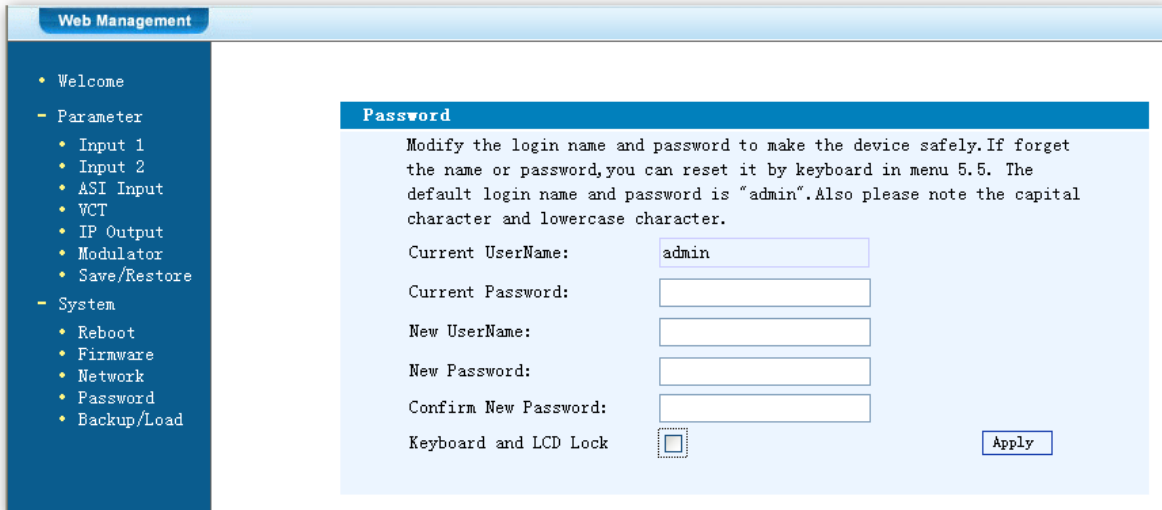

Figure-14

Keyboard and LCD Lock

➤ **Keyboard and LCD Lock:** If it is marked with “√”, the LCD and keyboard will be locked to avoid unrelated users’ modifying or view the device information and configurations. User can’t operate the keyboard & LCD while only the device IP address can be noted in the LCD window.

**IP Address**  
**192.168.000.136**

## Backup/Load

Click “Backup/Load” from the menu, it will display the screen as Figure-15.

**Backup Configuration** – To back up the device configuration file to a folder

**Load Configuration** – If user needs to load the old configuration to the device, click “Browse” and find the backup configuration file path. After selecting the file, click “Load File” to load the backup file to the device.



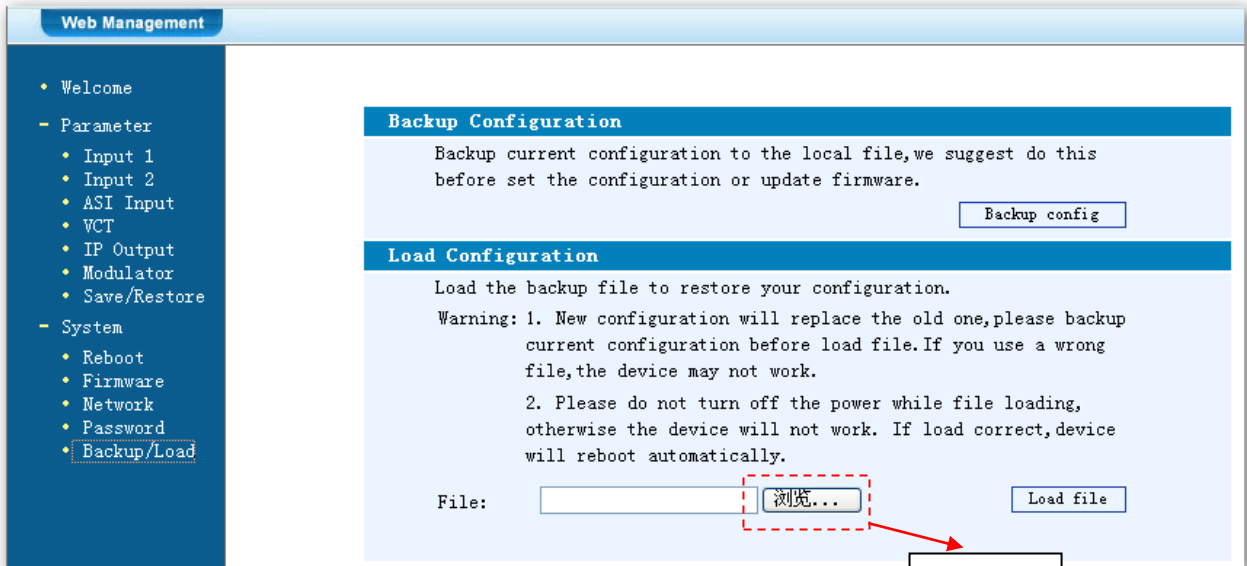

Figure-15

Browse  
Button

## Chapter 5 Troubleshooting

THOR's ISO9001 quality assurance system has been approved by the CQC organization. We guarantee the products' quality, reliability and stability. All THOR products haven't passed all testing and manual inspections before they are shipped out. The testing and inspection scheme already covers all the Optical, Electronic and Mechanical criteria which have been published by THOR. To prevent a potential hazard, please strictly follow the operation conditions.

### Prevention Measures

- Installing the device in a place where the environmental temperature is between 0 to 45 °C
- Making sure the unit has plenty of ventilation for the heat-sink on the rear panel; and other heat-sink bores if necessary
- Checking the AC input within the power supply and ensure it is working, the connection is correctly installed before switching on device
- Checking the RF output levels to stay within a tolerable range, if it is necessary
- Checking all signal cables have been properly connected
- Frequently switching on/off device is prohibited; the interval between every switching on/off must be greater than 10 seconds.

### Conditions needed to unplug power cord

- Power cord or socket damage.
- Any liquid that got into the device.
- Any stuff that could cause a circuit short
- Device in damp environment
- Device has suffered from physical damage; i.e. it fell off a rack.
- Longtime idle.
- After switching on and restoring to factory setting, device still won't work properly.
- Maintenance needed on device

## Chapter 6 Application

### Application Examples

#### 1). Residences and Private Homes Video content DVB-T/ISDB-T distribution

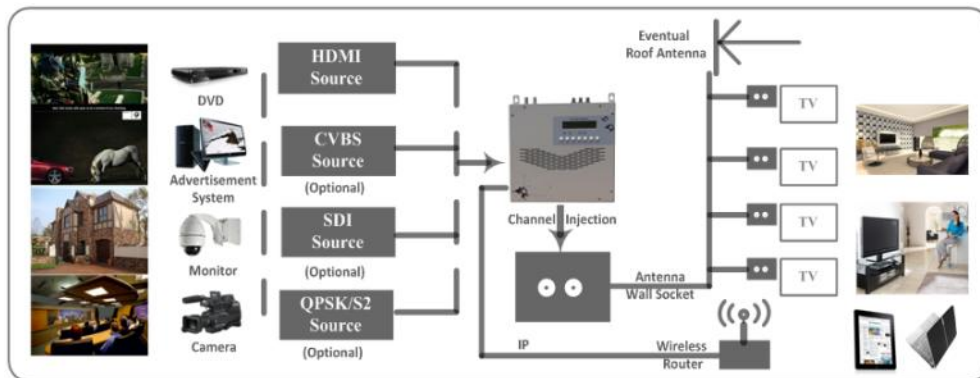

#### 2) Outside Audio- Video contents ON- AIR DVB- T/ISDB-T distribution

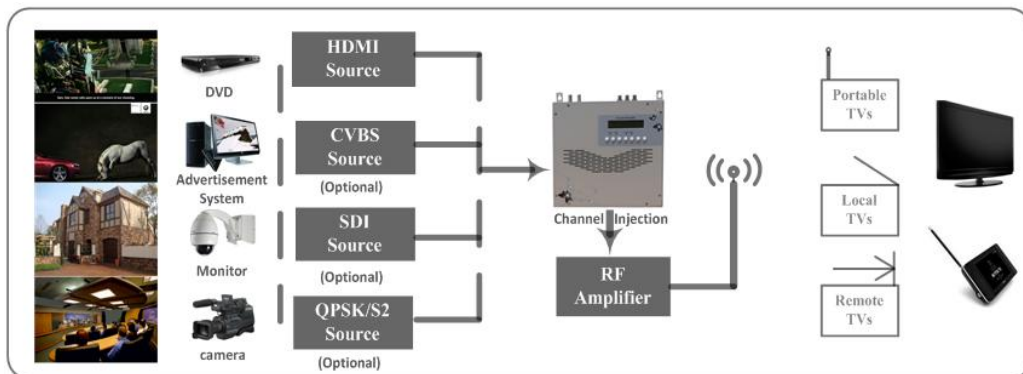

#### 3) Hotel Audio- Video contents DVB- T/ISDB-T distribution

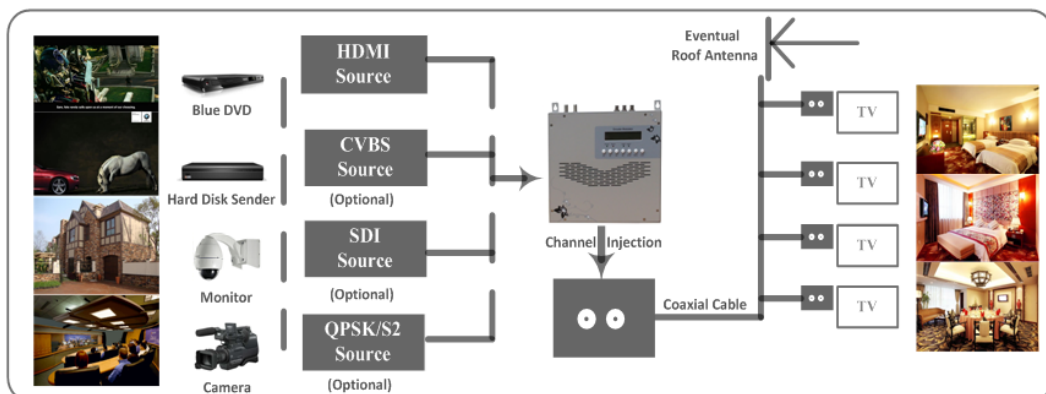

## 4) Bar Audio- Video contents distribution

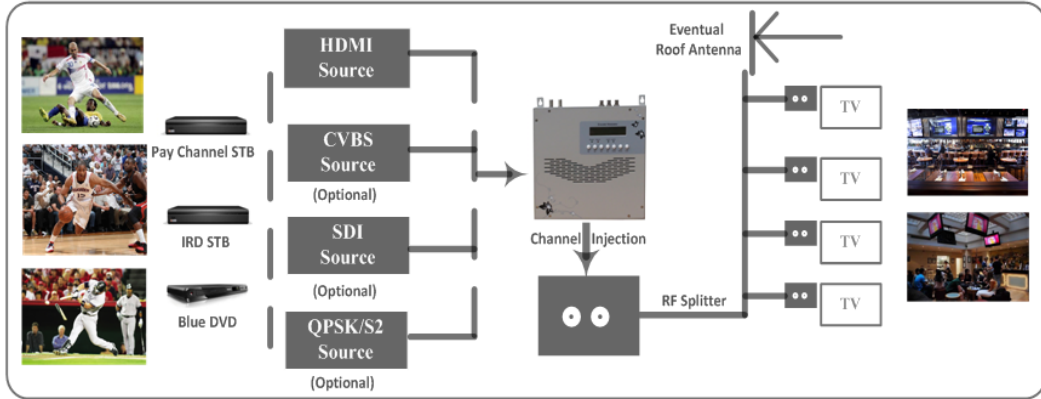

## 5) Cinema Audio- Video contents DVB- T/ISDB-T distribution

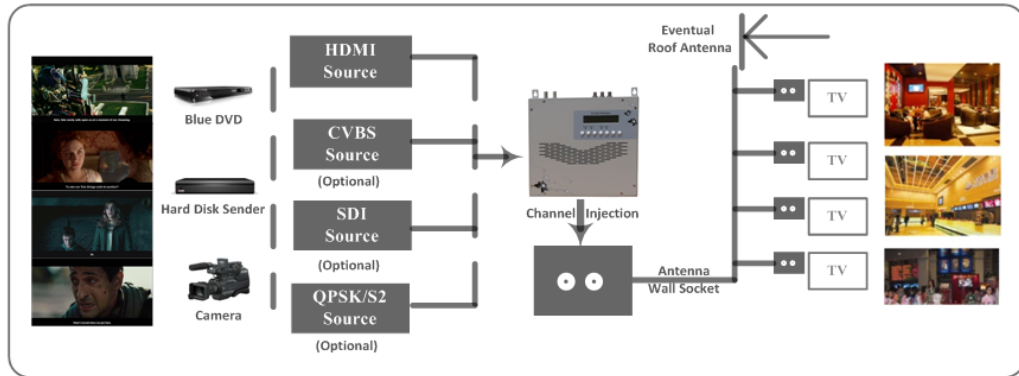

## 6) Company Audio- Video contents distribution

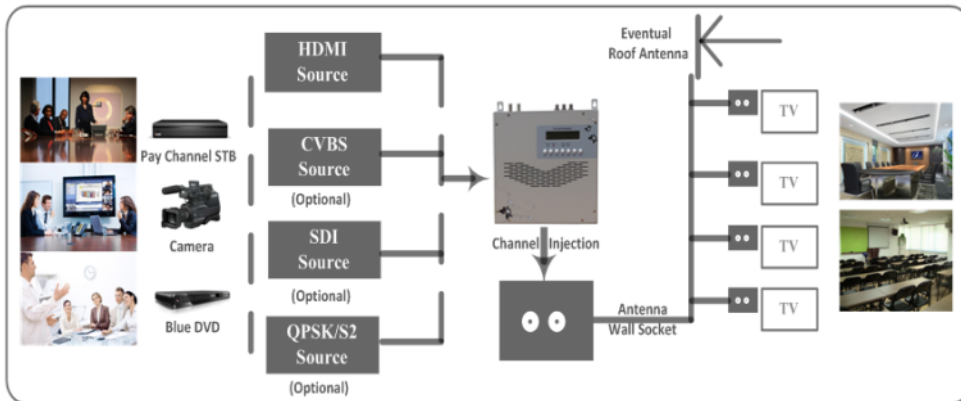

## Chapter 7 Packing List

4-HDMI-ATSC-IP Encoder Modulator	1PC
User Manual	1PC
HDMI Cables	4PCs
Power Cord	1PC