

THOR BROADCAST

User Manual



1-4 HDMI & SDI Encoder Modulator H-XX-SDI-QAM-IPLL H-XX-HDMI-QAM-IPLL

Revision 06212017

A Note from Thor Broadcast about this Manual

Intended Audience

This user manual has been written to help people who have to use, integrate and to install the product. Some chapters require some prerequisite knowledge in electronics and especially in broadcast technologies and standards.

Disclaimer

No part of this document may be reproduced in any form without the written permission of Thor Broadcast.

The contents of this document are subject to revision without notice due to continued progress in methodology, design and manufacturing. Thor shall have no liability for any error or damage of any kind resulting from the use of this document.

Copy Warning

This document includes some confidential information. Its usage is limited to the owners of the product that it is relevant to. It cannot be copied, modified, or translated in another language without prior written authorization from Thor Broadcast.

Table of Contents

CHAPTER 1 - INTRODUCTION	4
1.1 <i>PRODUCT OVERVIEW</i>	4
1.2 <i>KEY FEATURES</i>	4
1.3 <i>PRINCIPLE CHART</i>	5
1.4 <i>SPECIFICATIONS</i>	5
CHAPTER 2 - INSTALLATION GUIDE	8
2.1 <i>GENERAL PRECAUTIONS</i>	8
2.2 <i>POWER PRECAUTIONS</i>	8
2.3 <i>DEVICE'S INSTALLATION FLOW CHART ILLUSTRATE AS FOLLOWING:</i>	8
2.4 <i>ENVIRONMENT REQUIREMENT</i>	9
2.5 <i>GROUNDING REQUIREMENT</i>	10
CHAPTER 3 - OPERATION	11
3.1.1 <i>ILCD MENU STRUCTURE</i>	11
3.1.2 <i>INITIAL STATUS</i>	13
3.2 <i>GENERAL SETTING FOR MAIN MENU</i>	13
CHAPTER 4 - WEB NMS OPERATION	20
4.1 <i>LOGIN</i>	20
4.2 <i>OPERATION</i>	21
ENCODER MODULATOR QUICK SETUP WITH GUI & VCT	32
<i>INTRO – GUI & VCT</i>	33
.....	36
<i>VIRTUAL CHANNELS</i>	37
ENCODER MODULATOR IPTV SETUP	43
<i>INTRO</i>	44
CHAPTER 5 - TROUBLESHOOTING	49
CHAPTER 6 -PACKING LIST	50
CHAPTER 7 - APPLICATION	51
7.1 <i>APPLICATION EXAMPLE</i>	51
APPENDIX	53

Chapter 1 - Introduction

1.1 Product Overview

The Thor Broadcast HDMI and SDI encoder modulators are an all-in-one device that integrates encoding (MPEG-2, MPEG-4/AVC H.264), modulation, and converts HDMI/SDI (model dependent) to a digital RF output signal and IPTV stream simultaneously.

To meet various requirements, these Thor Broadcast Pro-DVB headend units are also equipped with 1 ASI input, and outputs with 2 ASI ports and 1 IP port.

The signal source could vary from satellite receivers, closed-circuit television cameras, Blu-ray players, and antenna (off air). Its output signals are to be received by TVs, STB, etc. with the correlated standard the unit is set to encode with QAM (ATSC, DVB-T, DVB-C).

The ever popular low latency modulators are widely used everywhere such as the mall, market hall, theatre, hotels, restaurants, stadiums, race tracks, amphitheaters and etc. for advertising, monitoring, training and educating in company, schools, campuses, and healthcare. Recently these units have been deployed in countless professional and collegiate stadiums, universities, house of worship, Nascar and other various raceways for their power and ease of use.

1.2 Key features

- **HDMI/SDI... (1-4)inputs, 1*ASI in for re-mux; 1*RF in for RF mux**
- **MPEG2 HD/SD & MPEG4 AVC H.264 HD/SD video encoding**
- **1/ 2* channels in**
- **MPEG4-AAC; MPEG2-AAC; MPEG1 Layer II and Dolby Digital AC3 2.0(Optional) audio encoding**
- **Dolby Digital AC3 pass through**
- **Huge video buffer (for SDI interface), free to switch video sources**
- **Dialog Normalization(Optional)**
- **CC (closed caption) for SDI**
- **Support low delay encoding mode**

- VBR/CBR rate control mode
- PSI/SI editing
- PCR adjusting
- PID re-mapping and pass through
- DVB-C RF out and ASI out; IP out
- LCN (Logical Channel Number) support
- Modular design 1RU
- LCD display, Remote control and firmware
- Web-based NMS management; Updates via web
- Lowest cost per channel

1.3 Principle Chart

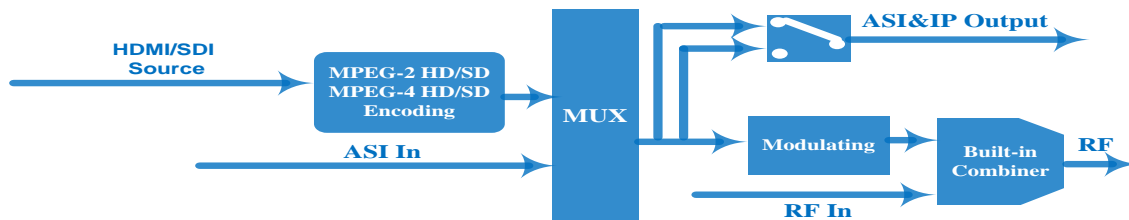

1.4 Specifications

HDMI Encoding Input 	Video	Input	Option 1: HDMI*1 Option 2: HDMI*2
		Encoding	MPEG2; MPEG4 AVC/H.264 (for option 1: HDMI*1) MPEG4 AVC/H.264 (for option 2:HDMI*2)
		Bitrate	1-19.5Mbps
		Resolution	1920*1080_60P, 1920*1080_50P, (-for MPEG4 AVC/H.264 only) 1920*1080_60i, 1920*1080_50i, 1280*720_60p, 1280*720_50P 720*480_60i, 720*576_50i
		Low Delay	Normal, Mode 1, Mode 2 (for option 1: HDMI*1)
		Rate Control	VBR/CBR
		Chroma	4:2:0
		Aspect Ratio	16:9,4:3
		Audio	Encoding
	Sample rate		48KHz
	Bitrate		64/96/128/ 192/256/320kbps

SDI Encoding Input 		Input	Option 1:SDI*1 Option 2:SDI*2
		Encoding	MPEG2; MPEG4 AVC/H.264
		Bitrate	1-19.5Mbps
		Resolution	1920*1080_60P, 1920*1080_50P, (-for MPEG4 AVC/H.264 only) 1920*1080_60i, 1920*1080_50i, 1280*720_60p, 1280*720_50P 720*480_60i, 720*576_50i
		Low Delay	Normal, Mode 1, Mode 2
		Rate Control	VBR/CBR
		Chroma	4:2:0
		Aspect Ratio	16:9,4:3
	Audio	Encoding	MPEG1 Layer II ,MPEG2-AAC, MPEG4-AAC and Dolby Digital AC3 2.0(Optional)
		Sample rate	48KHz
Bitrate		64/96/128/ 192/256/320kbps	

Modulator Section	DVB-C	Standard	J.83A (DVB-C), J.83B, J.83C			
		MER	≥43dB			
		RF frequency	30~960MHz, 1KHz step			
		RF output level	-30~ -10dbm (77~97 dbμV), 0.1db step			
		Symbol rate	5.000~9.000Mpsps adjustable			
		RF Out	1*DVB-C; 4*DVB-C carriers combined output			
			J.83A	J.83B	J.83C	
		Constellation	16/32/64/1 28/256QAM	64/ 256 QAM	64/ 256 QAM	
		Bandwidth	8M	6M	6M	

General	System	Local interface	LCD + control buttons		
		Remote management	Web NMS		
		Stream Out	2 ASI out (BNC type); IP (MPTS/SPTS) out (RJ45, 100M)		
		NMS interface	RJ45, 100M		
		Language	English		
	Physical Specification	Power supply	AC 100V~240V		
		Dimensions	482*300*44mm (19" rack) 267*250*44mm (portable)		
		Weight	4.5 kg (19" rack) 2.5 kg (portable)		
		Operation temperature	0~45℃		

1.5 Appearance and Description

Front Panel Illustration

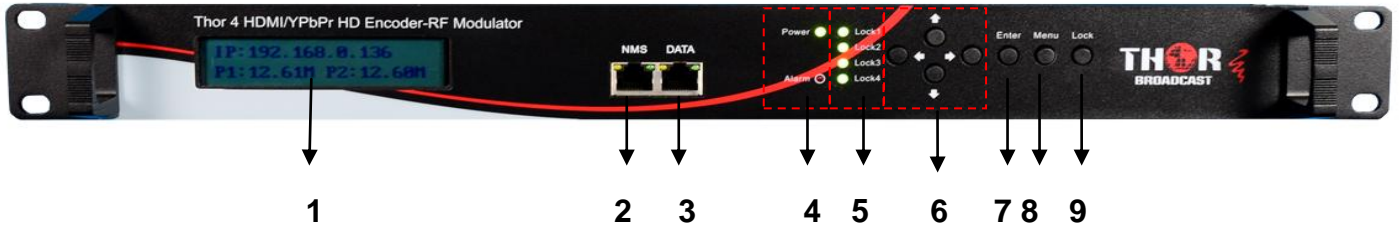

- ① LCD Screen
- ② NMS Port
- ③ Data Port
- ④ Power and Alarm Indicators
- ⑤ TS Lock Indicators
- ⑥ Directional: Up, Down, Left, and Right Buttons
- ⑦ Enter Button: to confirm
- ⑧ Menu Button : to go back one step
- ⑨ Lock Button: press to lock set

Rear Panel Illustration



- ① HDMI or HD-SDI input port
- ② RF In Port
- ③ RF Out Port
- ④ ASI Input Port
- ⑤ ASI Output port 1&2
- ⑥ Power Switch
- ⑦ Power supply socket
- ⑧ RF out port
- ⑨ Grounding

Chapter 2 - Installation Guide

Please read the entire section in full before installing or operating your new Thor Broadcast encoder to eliminate any chance of creating a faulty environment or recklessly damaging the unit.

2.1 General Precautions

- ✓ Must be operated and maintained in an area free of dust and debris.
- ✓ The cover should be securely fastened, do not open the cover of the chassis when the power is on. This will also void Thor's manufacturer's warranty.
- ✓ After installation, securely stow away all loose cables, external antenna, and others.

2.2 Power precautions

- ✓ Be careful when connecting a power source to the device.
- ✓ Do not operate in wet or damp areas. Make sure the extension cable is in good condition
- ✓ Make sure the power switch is off before you start to install the device

2.3 Device's Installation Flow Chart Illustrate as following:

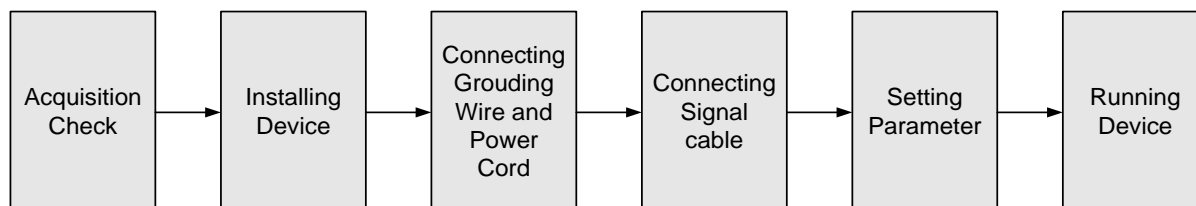

2.4 Environment Requirement

Item	Requirement
Rack Space	When installing unit on rack, the distance between 2 rows of machine frames should be 1.2~1.5m and the distance against wall should be no less than 0.8m.
Rack Room	Electric Isolation, Dust Free, HVAC anti-static material: $1 \times 10^7 \sim 1 \times 10^{10} \Omega$, Grounding current limiting resistance: $1 M\Omega$ (Floor bearing should be greater than 450Kg/m^2)
Environment Temperature	$5 \sim 40^\circ \text{C}$ (sustainable), $0 \sim 45^\circ \text{C}$ (short time), installing air-conditioning is recommended
Relative Humidity	20%~80% sustainable 10%~90% short time
Pressure	86~105KPa
Door & Window	Installing rubber strip for sealing door-gaps and dual level glasses for window
Fire Protection	Fire alarm system and extinguisher
Power	Device power, HVAC and lighting should be independent to each other. Device power requires AC $110\text{V} \pm 10\%$, 50/60Hz or AC $220\text{V} \pm 10\%$, 50/60Hz. Please carefully check before running.

2.5 Grounding Requirement

- ✓ It is important to keep this device grounded to ensure all of the modules function correctly. Correctly grounding the device will also help prevent any electrical interference, lightning. Etc. Also it helps reject minor interference that may disrupt the devices ability to function smoothly. General rule of them, make sure the device is grounded when installing anywhere.

- ✓ Always use copper wire. When applied correctly the ground must be wrapped well to ensure maximum conduction so it can reduce any high frequencies. The copper ground wire should also be as short and thick as possible

- ✓ Installer must make sure that the two ends of the ground are well conducted and have appropriate anti-rust properties.

- ✓ It is prohibited to use any other device as part of the grounding electric circuit.

- ✓ The area of the conduction between the ground wire and device's frame should be no less than 25 m².

Chapter 3 - Operation

Keyboard Function Description:

MENU: Cancel current entered value, resume previous setting; Return to previous menu.

ENTER: Activate the parameters which need modifications, or confirm the change after modification.

LEFT/RIGHT: Choose and set the parameters.

UP/DOWN: Modify activated parameter or paging up/down when parameter is inactivated.

LOCK: Lock the screen/cancel the lock state. After pressing the lock key, the LCD will display the current configuring state.

3.1.1LCD Menu Structure

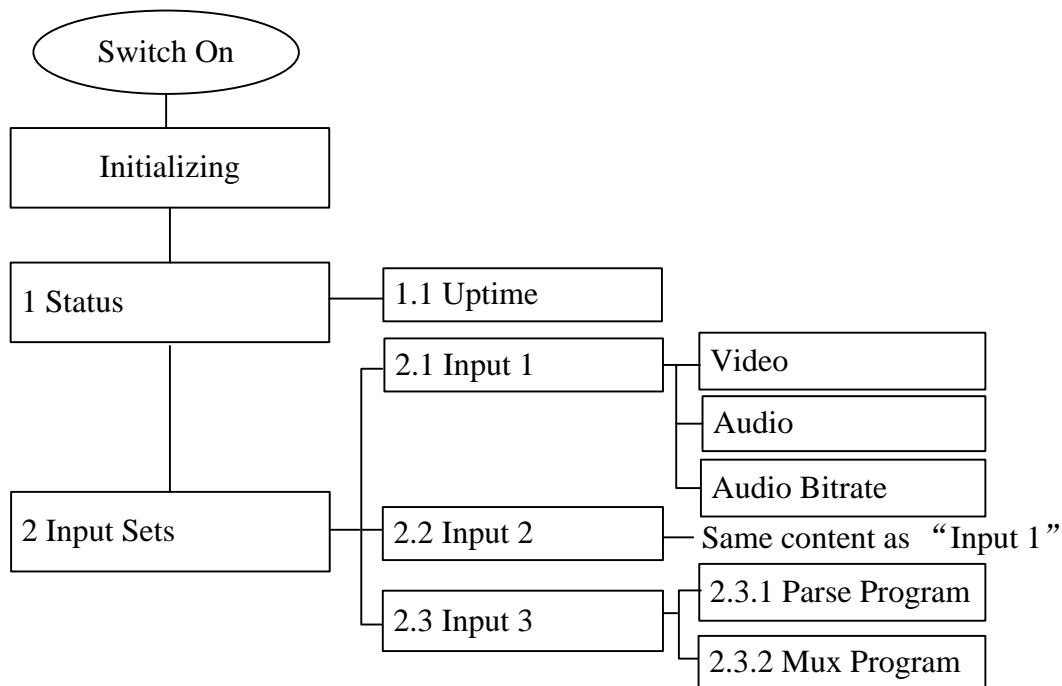

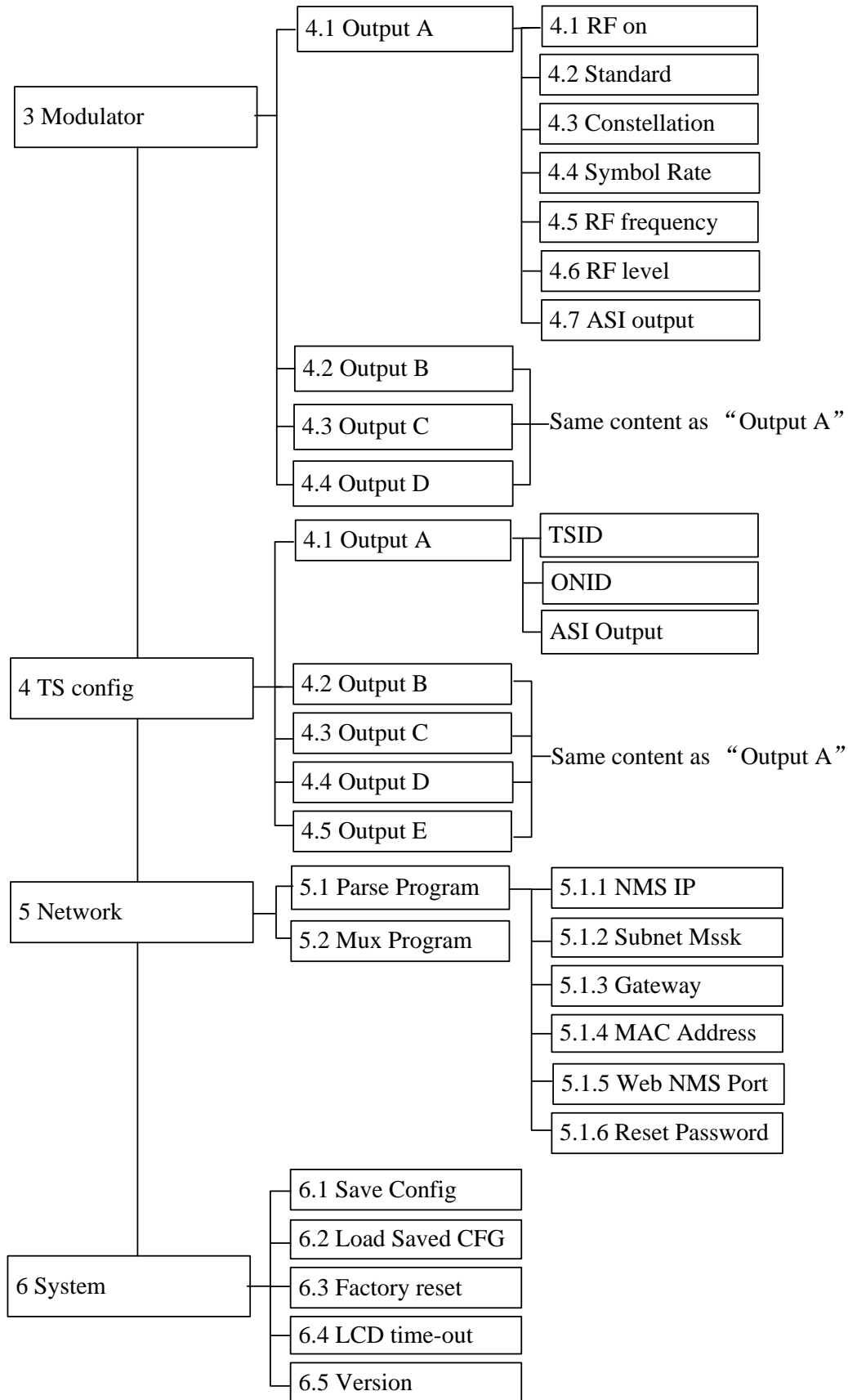

3.1.2 Initial Status

After powering on the device, it will take a few seconds to initialize the system

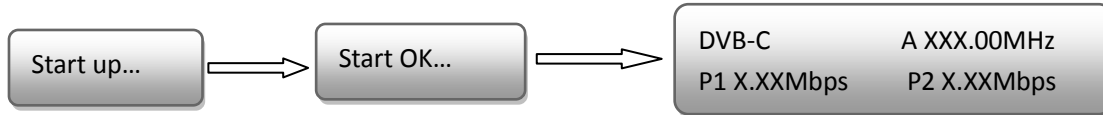

- **DVB-C:** indicates the modulation standard of this device.
- **A/B/C/D:** indicates the 4 carrier outputs
- **XXX.XX MHz:** Indicates the current output frequency (Range: 30~999MHz) of the 4 carriers output.
- **X.XX Mbps:** Indicates the encoding bitrate of each encoding output respectively.

3.2 General setting for Main Menu

By pressing the “Lock” key on the front panel, enter the main menu. The LCD will display the following pages:

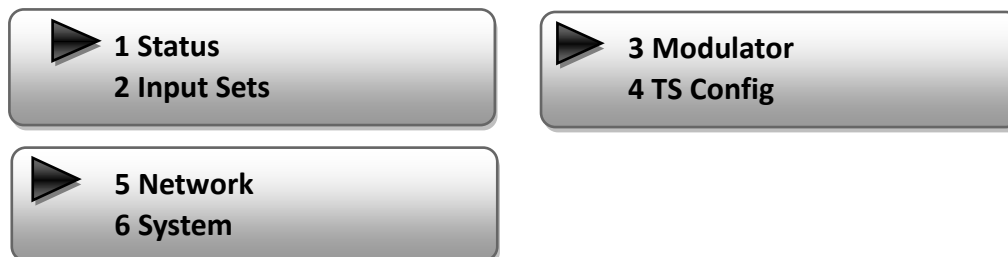

Press UP/DOWN buttons to specify menu items, and then press ENTER to enter the submenus as below:

1) Status

Press Enter to enter “Status” and it displays the working time duration of the device

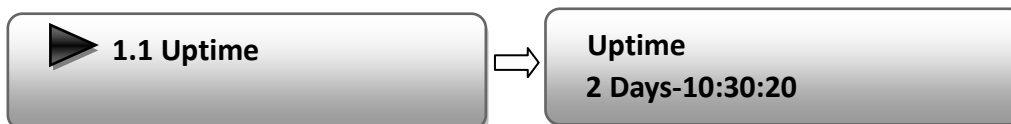

2) Input Sets

Under this submenu, the LCD will show “2.1 Input 1”, “2.2 Input 2” and “2.3 Input 3”.



Under submenus 2.1 and 2.2, set the audio, video and program information for each encoding input.

Enter Video Input to set the video corresponding parameters.



Video in Status Locked	Resolution 1920 × 1080 50i
Video format MPEG-2 H.264	Video Bit rate 12.000Mbps
Low delay Normal Model1 Model2 Manual	CC Switch EIA608 EIA708 Line21 CC OFF
B frame 2	P frame 4
DTS delay 200	

Note: Supports CC for SDI encoding only

Under submenu 2.2, set the audio corresponding parameters.



➤ **Audio format**

Under the “Audio” submenu, select the audio format for this encoding input source, these Thor Broadcast encoders support MPEG-1 Layer II, MPEG-2 AAC, MPEG-4 AAC and AC3.



➤ **Dialog Normal**

Set the dialog level of this device



Under Audio Bit Rate can be selected by pressing “enter” key. (Bit rate range: 64/96/128/192/256/320 Kbps):

Audio Bitrate
 64Kbps

Users enter 2.3 to check the programs information and set the programs parameters.

Program Info

Program Output Program out enable A	Program Name TV-101
Service provider TV provider	SUB-Channel Number 1
PMT PID 0×100	PCR PID 0×103
Video PID 0×101	Audio PID 0×102

Submenu 2.3 represents the ASI input. You can parse and select program(s) to mux out.

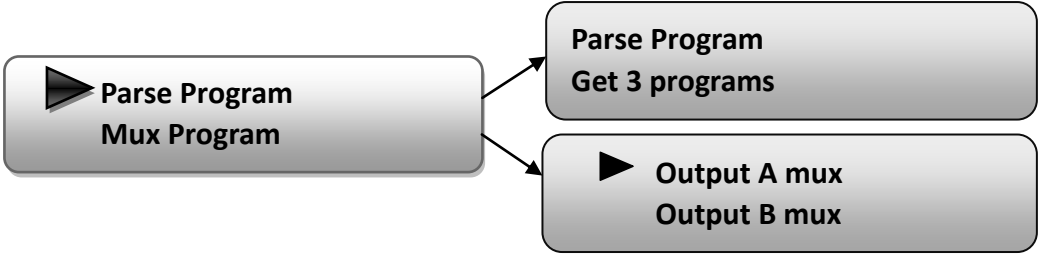

“Parse Program” is for checking the quantity of input programs from the corresponding Tuner input.

“Mux Program” is for selecting programs from the ASI IN to multiplex with the output via corresponding carrier output or ASI output (A, B, C, D, E optional). Move the triangle mark to specify the program and press RIGHT/LEFT keys to shift the mark between “v” and “X”. (“v”: to output the corresponding program; “X”: not to output the corresponding program)

3) Modulator Setting

When entering the “Modulator” submenu, configure the modulating parameters for the 4 carrier output separately:



The Thor Encoder Modulators (DVB-C Modulating) have 4 carrier outputs, “3.1”-“3.4” represent the “Carrier A”, “Carrier B”, “Carrier C”, and “Carrier D” respectively. Enter “3.1”/“3.2”/“3.4”/“3.4” to set the corresponding modulating parameters. Submenus (taking “3.1” as an example) are as below:

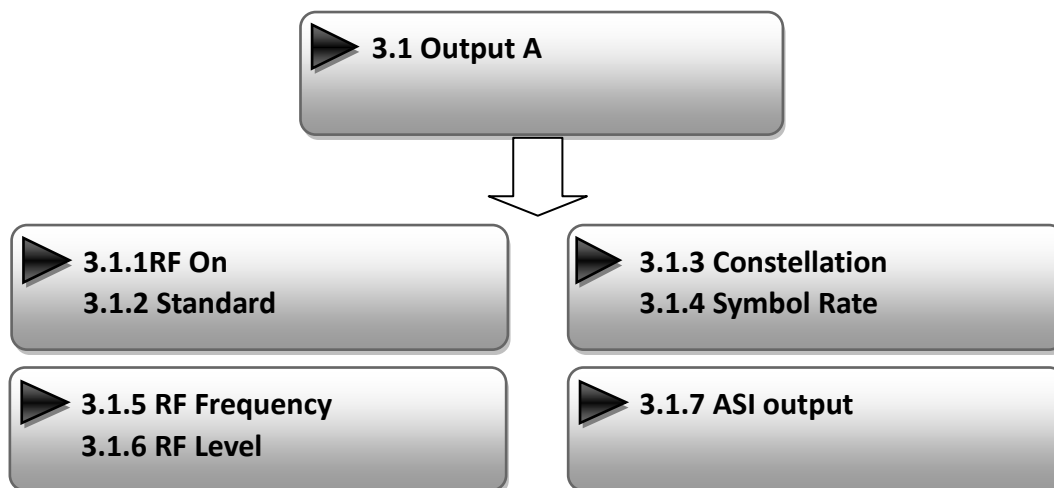

➤ RF On

This interface decides whether to enable the RF (carrier A) output or not.

OFF: to disable programs to output through carrier A.

ON: to enable programs to output through carrier A.



➤ Standard

There are three possible options provided for selecting your RF modulation **Standard:** J.83A(DVB-C), J.83B, J.83C when the display shows them, just swipe LEFT and RIGHT key to choose.

➤ Constellation

Three different constellations: J.83A (DVB-C), J.83B, J.83C will show on the LCD window when



HDMI/SDI-QAM-IPLL

Constellation been entered.

J.83A (DVB-C) contains 16QAM, 32QAM, 64QAM, 128QAM, and 256QAM;

J.83B contains 64QAM, 256QAM; THIS I NORTH AMERICA STANDARD

J.83C contains 64QAM, 256QAM.

16QAM: Quadrature Amplitude Modulation is 16

32 QAM: Quadrature Amplitude Modulation is 32

64QAM: Quadrature Amplitude Modulation is 64

128QAM: Quadrature Amplitude Modulation is 128

256QAM: Quadrature Amplitude Modulation is 256

When the display shows, swipe LEFT and RIGHT key to choose and press “ENTER” for confirm.

➤ Symbol Rate

The symbol rate range for both J.83A(DVB-C) & J.83C is 5Mps to 9Mps and J.83B is fixed and cannot be changed.

➤ RF Frequency

The RF output frequency range is from 30 to 999MHz with 1K stepping. After entering the RF frequency setting submenu, press LEFT, RIGHT, UP, and DOWN buttons to adjust the frequency and confirm by press ENTER button.

RF Frequency
750.000 MHz

➤ RF level

The RF attenuation range is from -30~-10dbm (81~97dbμV) with 0.1db step. After entering this setting submenu, shift UP/DOWN/LEFT/RIGHT key to set the output level and press ENTER to confirm.

RF Level
-10.0 dbm

➤ **ASI Output:**

These Thor modulator's (DVB-C Modulating) have a quad-carrier output A, B, C, D and 1 ASI output E.

Output A: the ASI output programs are same as carrier output A.

Output B: the ASI output programs are same as carrier output B.

Output C: the ASI output programs are same as carrier output C.

Output D: the ASI output programs are same as carrier output D.

Output E: the ASI output programs are set separately.

ASI Output
▶ **Output A**

4) TS Configuration

Enter each menu to configure the TS ID and Original Network ID for the 4 carriers and ASI output.

▶ **4.1 Output A**
4.2 Output B

▶ **4.3 Output C**
4.4 Output D

▶ **4.5 Output E**

5) Network

Network contains "5.1 NMS" and "5.2 IP Stream".

▶ **5.1 NMS**
5.2 IP Stream

"5.1 NMS" is for setting the network parameters for the connection between the device and PC.

▶ **5.1.1 NMS IP**
5.1.2 Subnet Mask

▶ **5.1.3 Gateway**
5.1.4 MAC Address

▶ **5.1.5 Web NMS Port**
5.1.6 Reset Password

NMS IP 192.168.000.136	Subnet mask 255.255.255.000
Gateway 192.168.000.001	MAC address 201110140940
Web Manage Port 00080	Reset password? Yes <input checked="" type="radio"/> NO

“IP Stream” is for configuring the 4 SPTS output respectively.

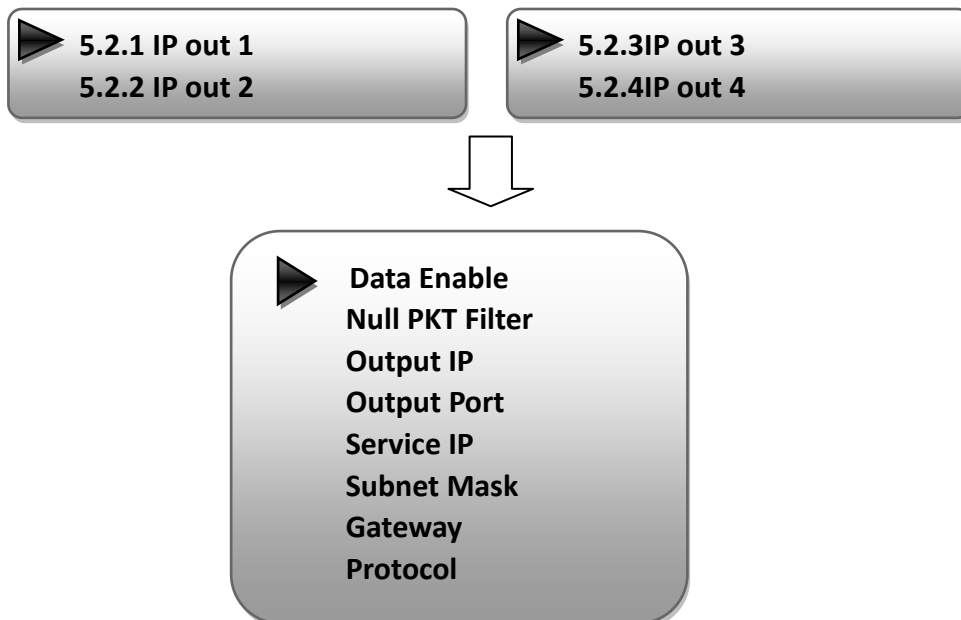

6) System

It contains 5 submenus where you can save/load configurations.

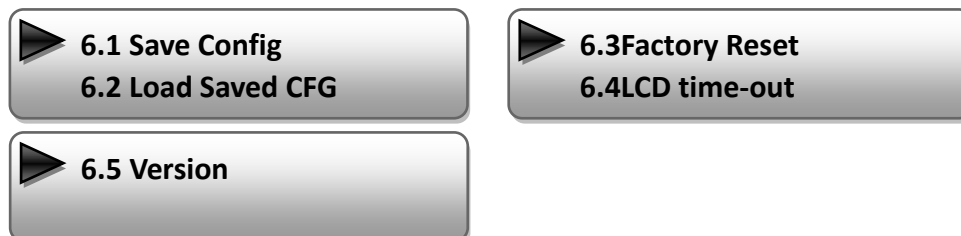

Chapter 4 - WEB NMS Operation

For setting configurations you can use the front panel; also you are able to control and set the configurations on any computer by connecting the device to the web NMS Port. You should ensure that the computer's IP address is different from the THOR 4-ADHD's IP address; otherwise, it would cause IP conflict.

4.1 Login

The default IP of this device is 192.168.0.136. We can modify the IP through the front panel.

Connect the pc and the device with net cable, and use ping command to confirm they are on the same network segment.

E.G. the PC IP address is 192.168.99.252, we then change the device IP to 192.168.99.xxx (xxx can be 0 to 255 except 252 to avoid IP conflict).

Use any web browser to connect the device with the PC by inputting the Encoder & Modulator's IP address in the browser's address bar and press Enter.

It will display the Login interface as Figure-1. Input the Username and Password (Both the default Username and Password are "admin".) and then click "LOGIN" to start the device setting

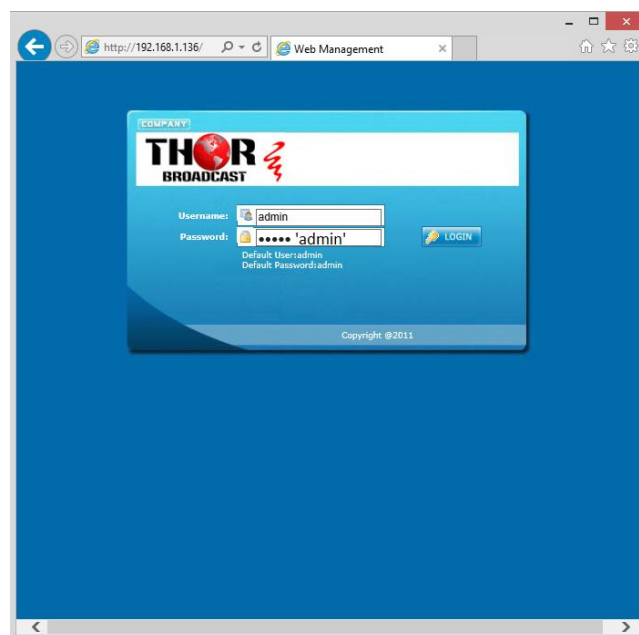
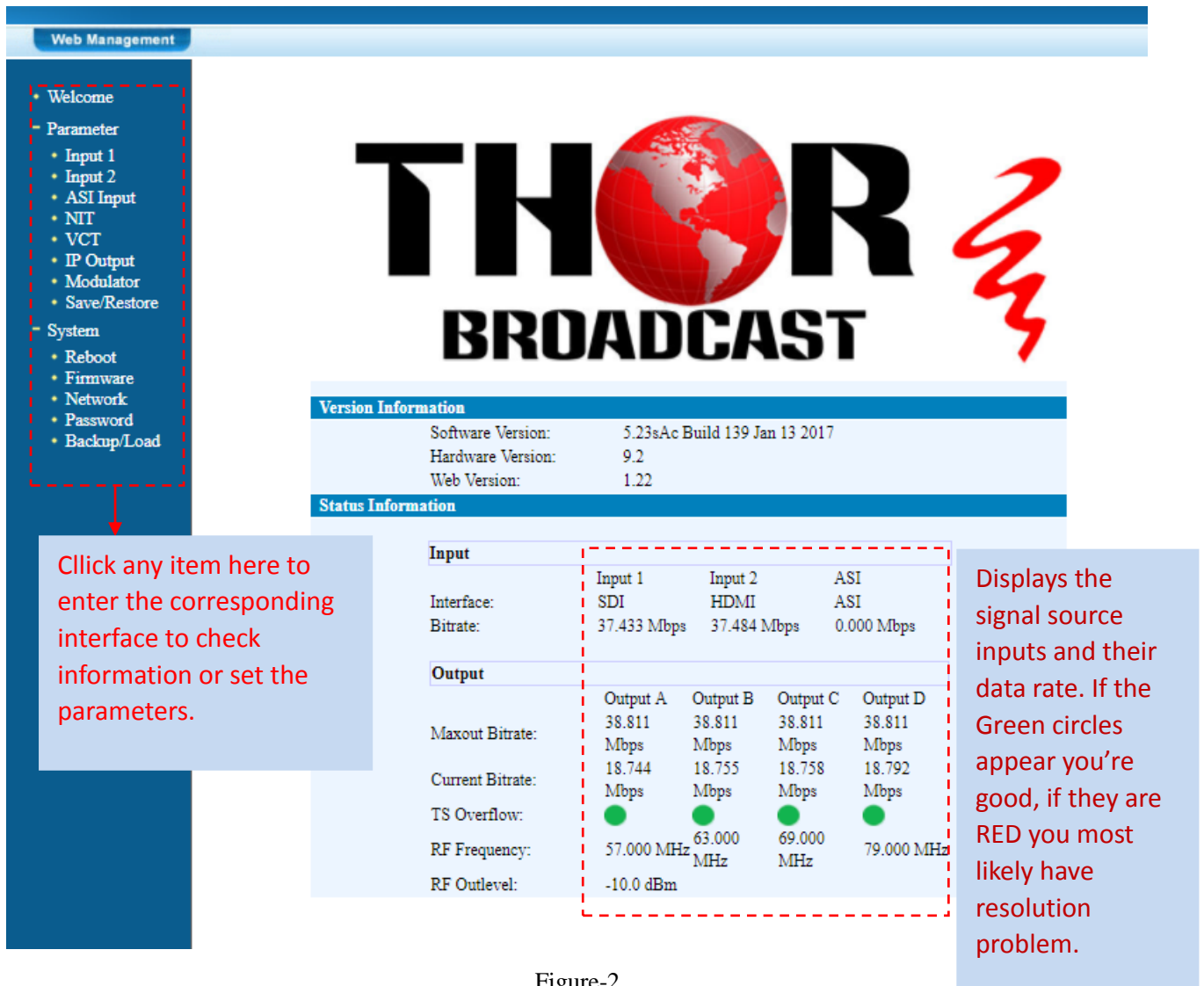

Figure-1

4.2 Operation

Welcome

When we confirm the login, it displays the WELCOME interface.



The screenshot shows the THOR Broadcast web management interface. On the left is a navigation menu with categories: Welcome, Parameter (Input 1, Input 2, ASI Input, NIT, VCT, IP Output, Modulator, Save/Restore), and System (Reboot, Firmware, Network, Password, Backup/Load). The main content area displays the THOR Broadcast logo and two information sections: Version Information and Status Information.

Version Information

Software Version:	5.23sAc Build 139 Jan 13 2017
Hardware Version:	9.2
Web Version:	1.22

Status Information

Input	Input 1	Input 2	ASI
Interface:	SDI	HDMI	ASI
Bitrate:	37.433 Mbps	37.484 Mbps	0.000 Mbps

Output	Output A	Output B	Output C	Output D
Maxout Bitrate:	38.811 Mbps	38.811 Mbps	38.811 Mbps	38.811 Mbps
Current Bitrate:	18.744 Mbps	18.755 Mbps	18.758 Mbps	18.792 Mbps
TS Overflow:	●	●	●	●
RF Frequency:	57.000 MHz	63.000 MHz	69.000 MHz	79.000 MHz
RF Outlevel:	-10.0 dBm			

Annotations on the screenshot:





- A red dashed box highlights the navigation menu, with a callout box stating: "Click any item here to enter the corresponding interface to check information or set the parameters."
- Another red dashed box highlights the Status Information table, with a callout box stating: "Displays the signal source inputs and their data rate. If the Green circles appear you're good, if they are RED you most likely have resolution problem."

Figure-2





Input 1

From the menu on the left side of the webpage, click "Input 1", it displays the information of the programs from the first 2 inputs you are encoding.

SDI Input Configuration Page

2CH Mpeg2/H.264 HD Encoder Configuration (EN14)		
Video Format	Mpeg2 ▼	H.264 ▼
Aspect Ratio	Auto ▼	16:9 ▼
Low delay	Normal ▼	Mode 1 ▼
Video Cache Bypass	Enable ▼	Disable ▼
CC Switch	EIA 708 ▼	CC Off ▼
Video BitRate(Mbps)	18.000	18.000
DTS Delay	200 (1-500)	200 (1-500)
GOP Bframe	2 (<=3)	2 (<=3)
Gop Pframe	4 (<=6)	4 (<=6)
H.264 Profile	Main Profile ▼	Automatic ▼
H.264 Level	Level 3.1 ▼	Level 3.1 ▼
Auto Config	<input checked="" type="checkbox"/>	<input checked="" type="checkbox"/>
Resolution	1920*1080_50i ▼	1920*1080_50i ▼
Audio Format	AC 3 ▼	Mpeg2 ▼
Dialog Normalization	-31 (-31 --1)dB	-31 (-31 --1)dB
Audio BitRate	192 Kbps ▼	192 Kbps ▼
Audio Gain(0-400%)	100%	200%
Audio Group	Group 1 ▼	Group 1 ▼
Audio Pair	Pair 1 ▼	Pair 1 ▼
Program Out Enable(ABCDE)	<input checked="" type="checkbox"/> <input type="checkbox"/> <input type="checkbox"/> <input type="checkbox"/> <input type="checkbox"/>	<input type="checkbox"/> <input checked="" type="checkbox"/> <input type="checkbox"/> <input type="checkbox"/> <input type="checkbox"/>
Service Provider	TV-Provider	TV-Provider
Program Name	TV-101	TV-102
SUB-CHANNEL NUMBER	1	1
PMT PID	0x100	0x104
Video PID	0x101	0x105
Audio PID	0x102	0x106
PCR PID	0x103	0x107
Video:		
Video Format:	1920x1080 59.94i	1920x1080 59.94i
Encoding:		
Bitrate:	18.710 Mbps	18.729 Mbps
Rom Version:	6.0.1.100	6.0.1.100
<input type="button" value="Help"/>		<input type="button" value="Default"/> <input type="button" value="Apply"/>

HDMI Input Configuration Page

2CH Mpeg2/H.264 HD Encoder Configuration (EN13)			
Video Format	Mpeg2	H.264	
Aspect Ratio	Auto	4:3	
Low delay	Normal	Mode 2	
Video BitRate(Mbps)	18.000	18.000	
DTS Delay	200 (1-500)	200 (1-500)	
GOP Bframe	2 (<=3)	2 (<=3)	
Gop Pframe	4 (<=6)	4 (<=6)	
H.264 Profile	Main Profile	Main Profile	
H.264 Level	Level 3.1	Level 3.1	
Auto Config	<input checked="" type="checkbox"/>	<input checked="" type="checkbox"/>	
Resolution	1920*1080_50i	1920*1080_50i	
Audio Format	AC 3	Mpeg2 AAC	
Dialog Normalization	-31 (-31 --1)dB	-31 (-31 --1)dB	
Audio BitRate	192 Kbps	192 Kbps	
Audio Gain(0-400%)	100	100	
Program Out Enable(ABCDE)	<input type="checkbox"/> <input type="checkbox"/> <input checked="" type="checkbox"/> <input type="checkbox"/> <input type="checkbox"/>	<input type="checkbox"/> <input type="checkbox"/> <input type="checkbox"/> <input checked="" type="checkbox"/> <input type="checkbox"/>	
Service Provider	TV-Provider	TV-Provider	
Program Name	TV-201	TV-202	
SUB-CHANNEL NUMBER	1	1	
PMT PID	0x200	0x204	
Video PID	0x201	0x205	
Audio PID	0x202	0x206	
PCR PID	0x203	0x207	
Video:			
Video Format:	1280x720 59.94p	1280x720 59.94p	
Encoding:			
Bitrate:	18.717 Mbps	18.731 Mbps	
Rom Version:	0.0.3.203	0.0.3.203	
Help		Default	Apply

Depending on whether you have an HDMI or HD-SDI encoder will allow you to change different options. For example CC is only available on SDI. All units have Low Latency and AC3 audio options.

Out Enable (ABCDE)

You can choose the output program from 4 carriers (A, B, C, D) or ASI(E).

Help Further assistance if necessary

Default Click this button to apply the default settings of Input 1

Apply Click this button to apply the modified parameters.

NOTE

The different combination of **Video Format, Video Bit-rate, Low Delay Mode** and the **Resolution** of signal source will have an impact on the latency. Please refer to the **Appendix** attached for detailed information. **Mode 1 is the Fastest.**

ASI Input

Click “ASI Input”, it will display ASI input program information as shown in Figure-4. Parse and multiplex ASI IN programs in this interface.

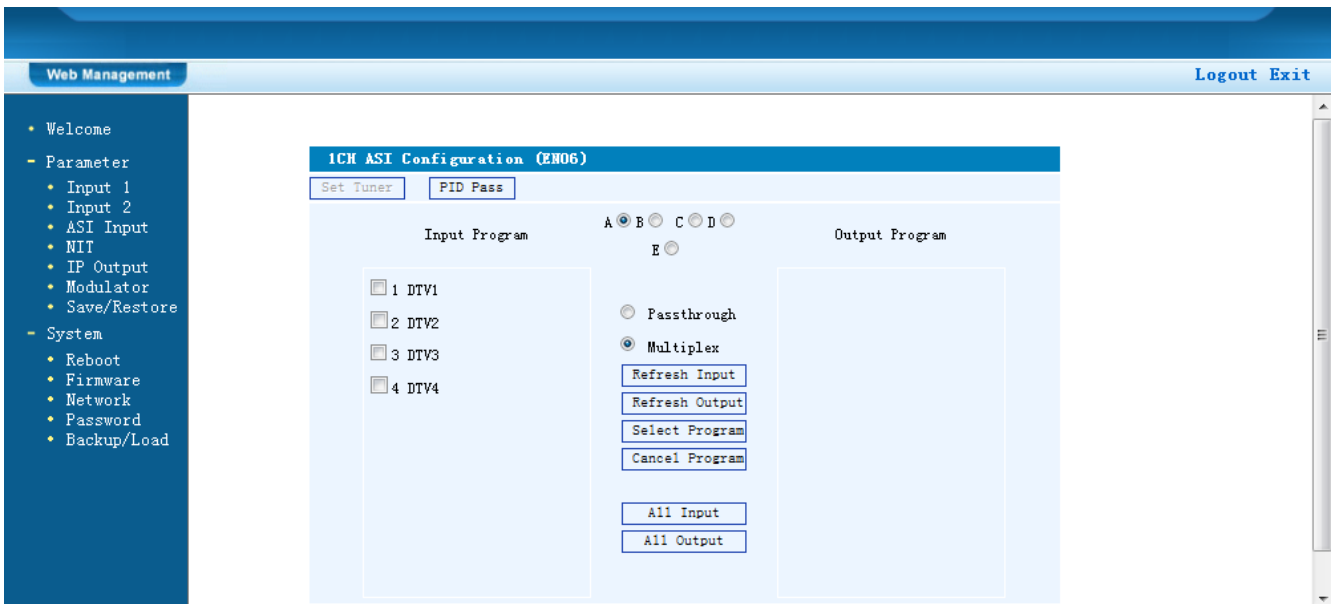

Figure-4

A B C D
E

The letters A to D represent the 4 carrier outputs. E represents the ASI output. Configure different program groups for each carrier output.

Passthrough If this item is selected, all the input programs will pass through without any elimination.

Multiplex Selecting this item will allow you to choose programs as needed to output.

Refresh Input Click “Refresh Input” to refresh the input program list.

Refresh Output Click “Refresh Output” to refresh the output program list.

Select Program When user checks one input program with “√”, one can transfer the checked program to the right box to output.

Select the programs which we want to output or we can output all the programs.

Cancel Program Similarly, cancel the multiplexed programs from the right box.

All Input & **All Output** to select all the input/output programs with a one-time click.

Parse timeout **seconds** Time limitation to parse the input programs

PID Pass Click this button to trigger a dialog box as shown below, where to add the PIDs which need pass through.

On some occasions, there are some PIDs which won't belong to any program, such as EPG, NIT tables and so on where the user just wants to pass them through the multiplexing module without changing anything. This is the main purpose of this function.

Number	Input PID	Output PID	Add
1	01	01	Del
2			Del

Apply Cancel Del-All

Click “Add” to add more boxes for filling the Input & Output PIDs, then click “Apply” to confirm.

NIT Table setting

Click “NIT” from the menu to trigger the screen below. Then click “Add” from this screen to add the program descriptor in NIT Table.

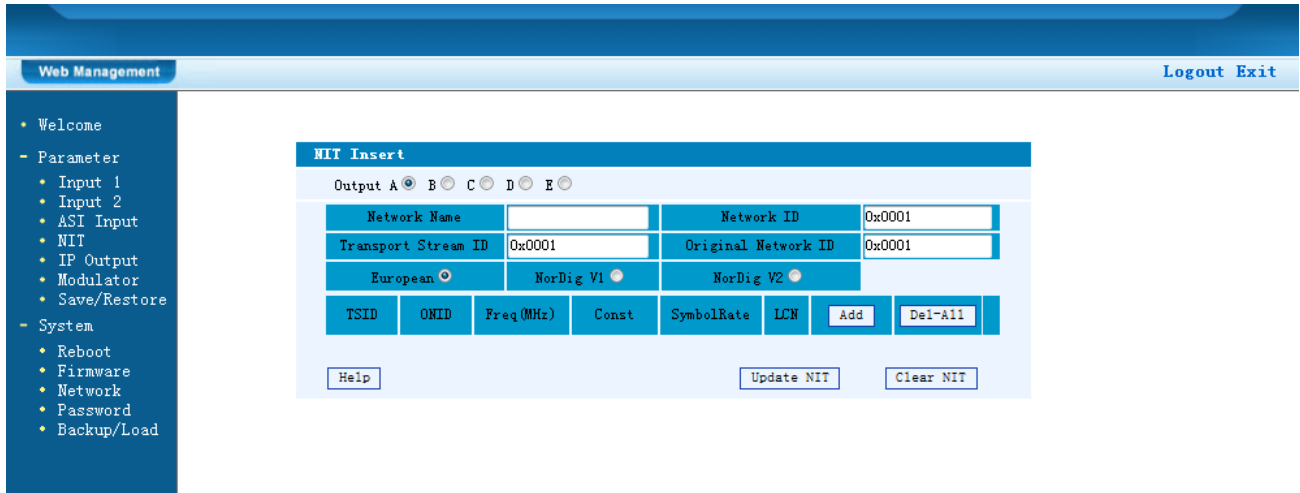

Figure-5

Add

Click “Add” from this page, it will display the screen as Figure-6 shows where it requires to add Service ID and configure other parameters for the programs.

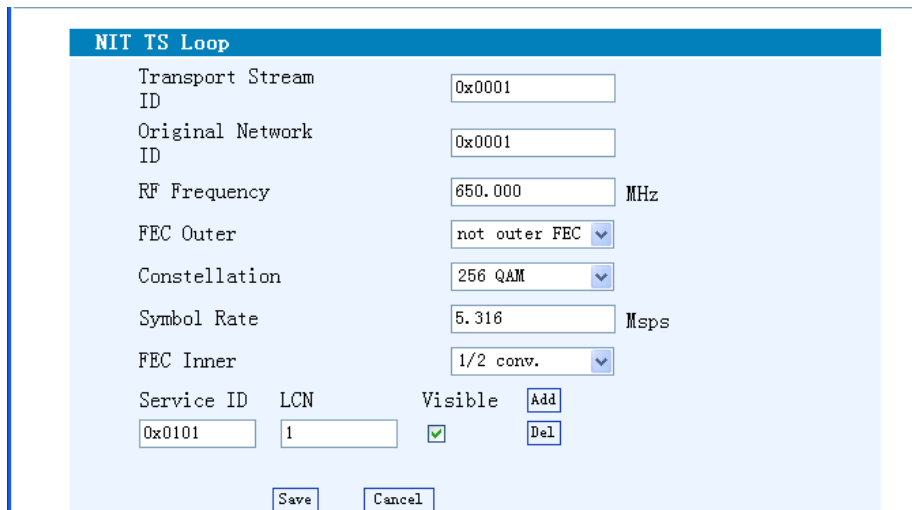

Figure-6

Add

Here by clicking “Add”, users can set the program LCN in its respective field. After setting all the data, click on “Save” **Save** to save the setting. Click “UpdateNIT” **Update NIT** to update the NIT information.

TSID	ONID	Freq(MHz)	Const	SymbolRate	LCN	Add	Del-All
0x0001	0x0001	650.000	256 QAM	5.316	yes	Detail	Del

Figure-7

IP Output

Click “IP Output” from the left menu, it will display the screen shown in Figure-8 where to configure the 4 IP SPTS Outputs.

After setting the parameters, click “Apply” to save the setting.

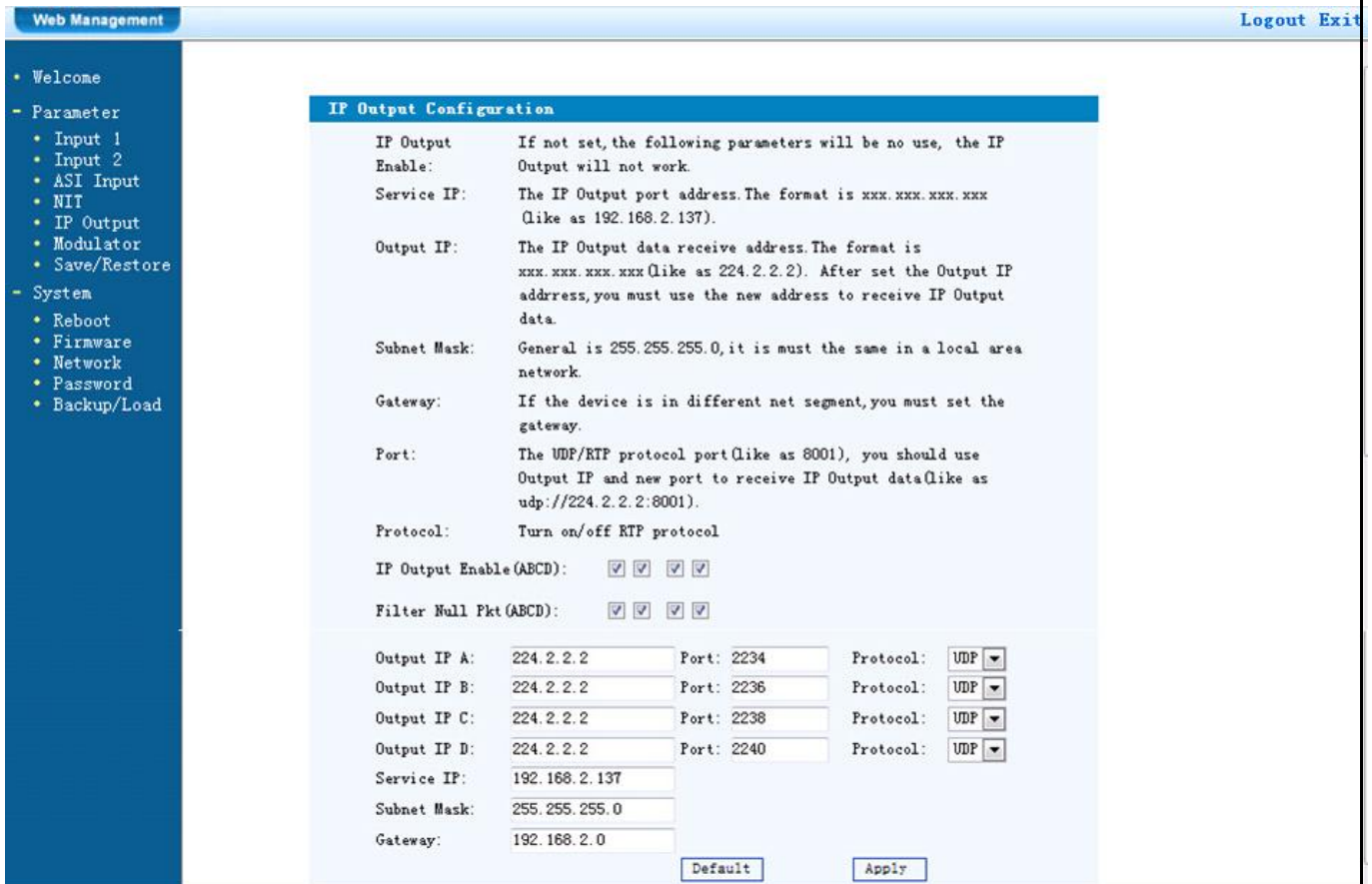

Figure-8

Modulator Setting

This unit is equipped with 4 adjacent frequency output. You can configure 4 carrier outputs here.

NOTE: Different modulation standards have different bandwidths. (See specifications in Chapter 1).

After setting all the parameters, click on “Apply” to save the Modulator parameters.

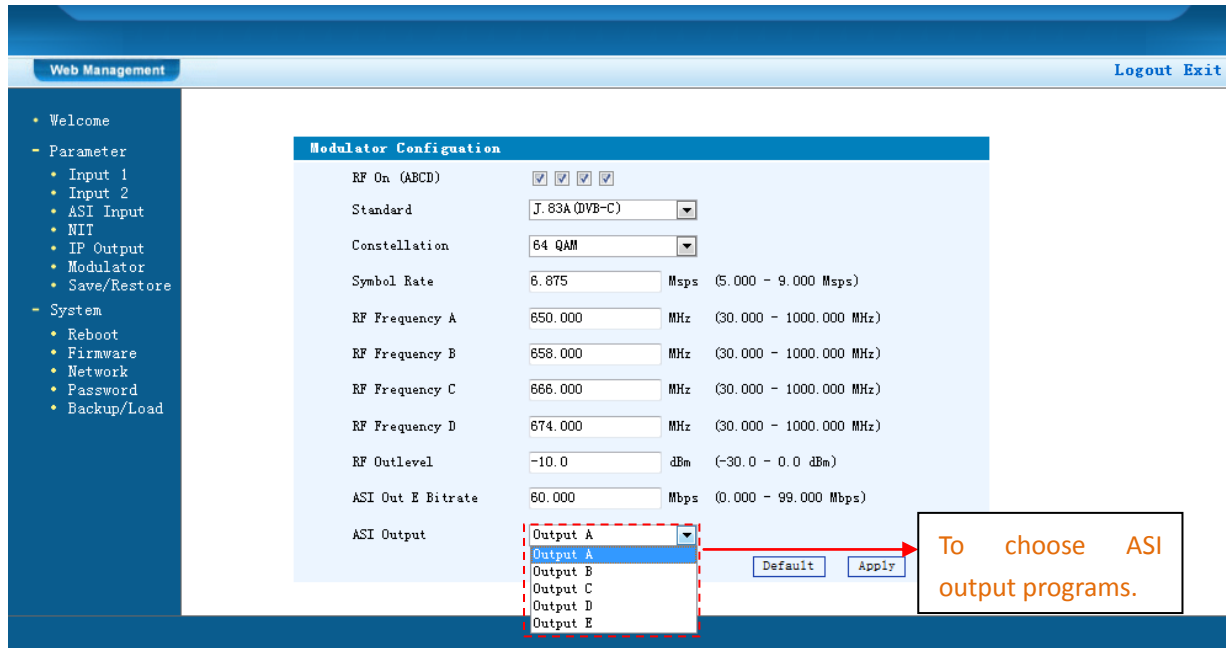

Figure-9

Save/Restore

Clicking “Save/Restore” from the menu, it will display the screen as Figure-10 where you can save the configuration permanently to the device. Click “Save Configuration”, for storing the data permanently to the device.

By using “Restore Configuration” you can restore the latest saved configuration to the device.

By using “Factory Set” you can import the default factory configuration.

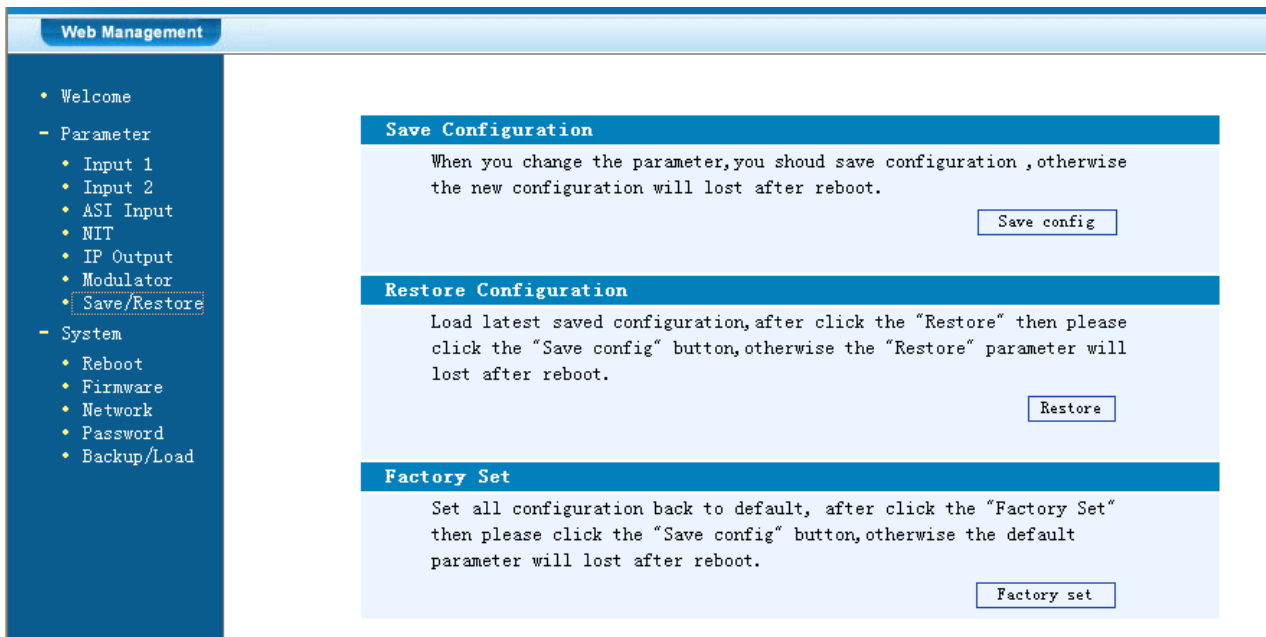

Figure-10

Restart the Device

Click “Reboot” from the menu, the screen will display Figure-11. Here, when clicking “Reboot” box, it will restart the device automatically.

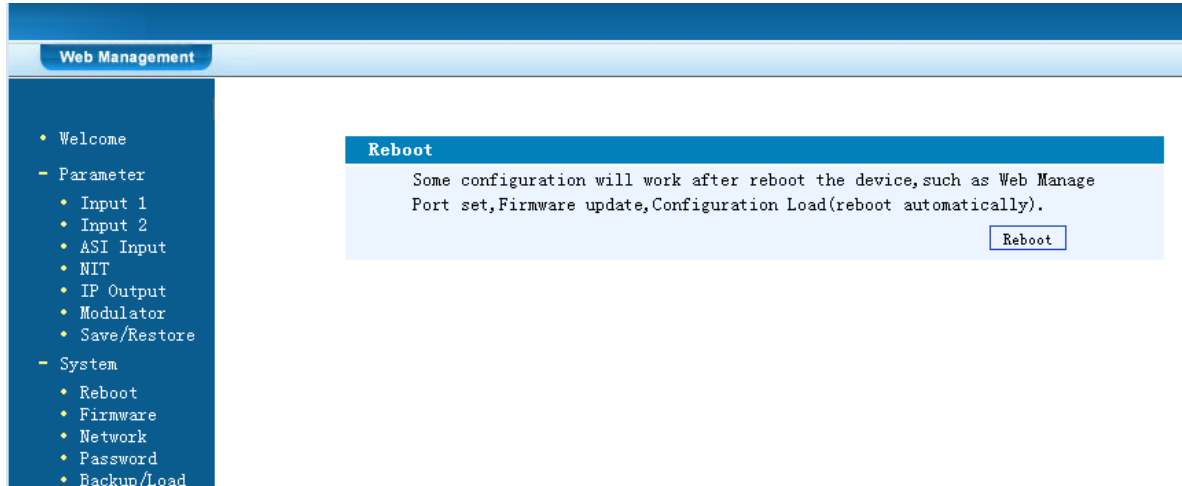

Figure-11

Update the Device

Click “Firmware” from the left menu it will display the screen as in Figure-12. Here you can update the device by using the update file.

Click “Browse” to find the path of the device update file for this device then click “Update” to update the device.

After updating the device, you need to restart the device by using Reboot option.

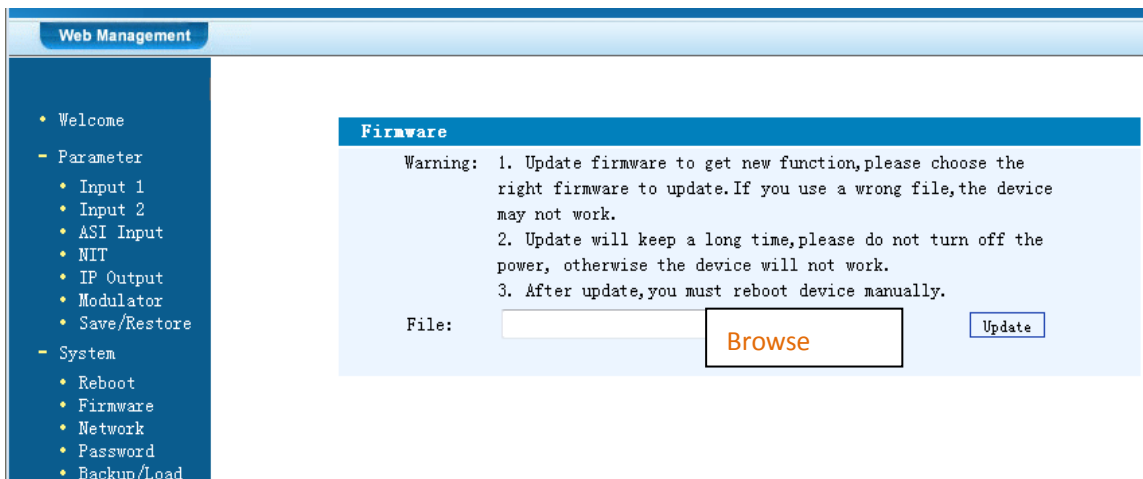

Figure-12

Network

When you click “Network”, it will display the screen as Figure-13. It displays the network information of the device. Here user can change the device network configuration as needed.

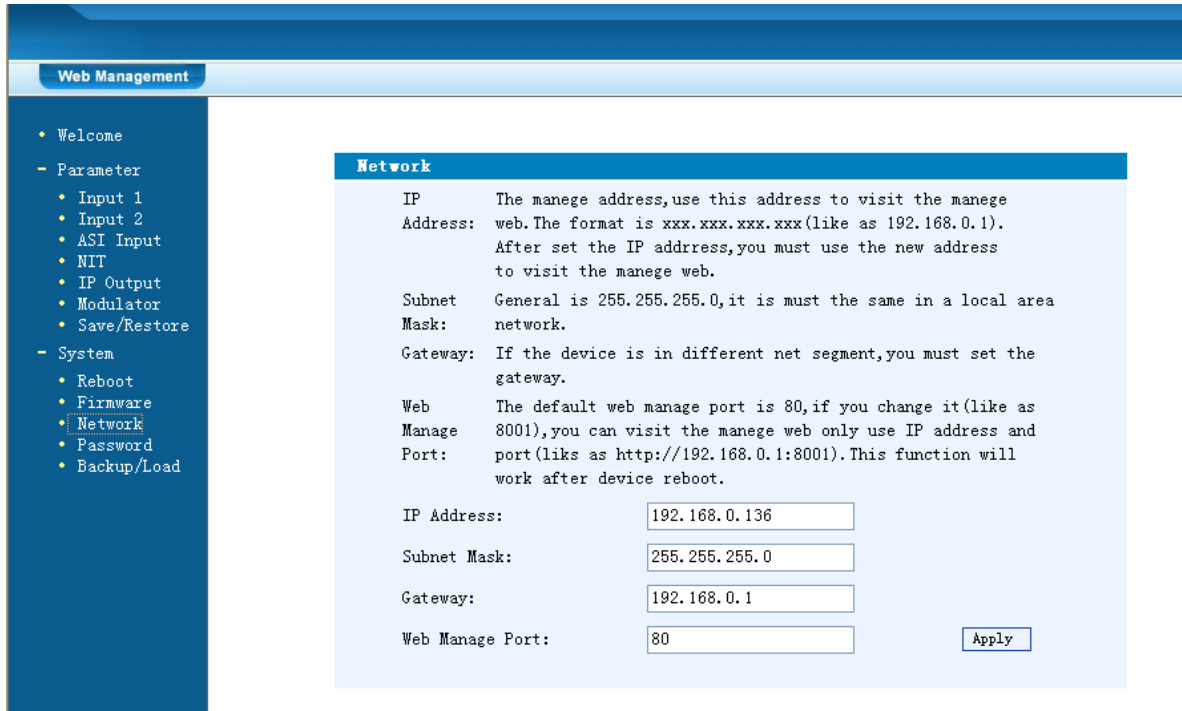

Figure-13

Change Password

When you click “Password”, it will display the password screen as in Figure-14. Here you can change the Username and Password for login to the device.

After putting the current and new Username and Password, click “Apply” to save the configuration.

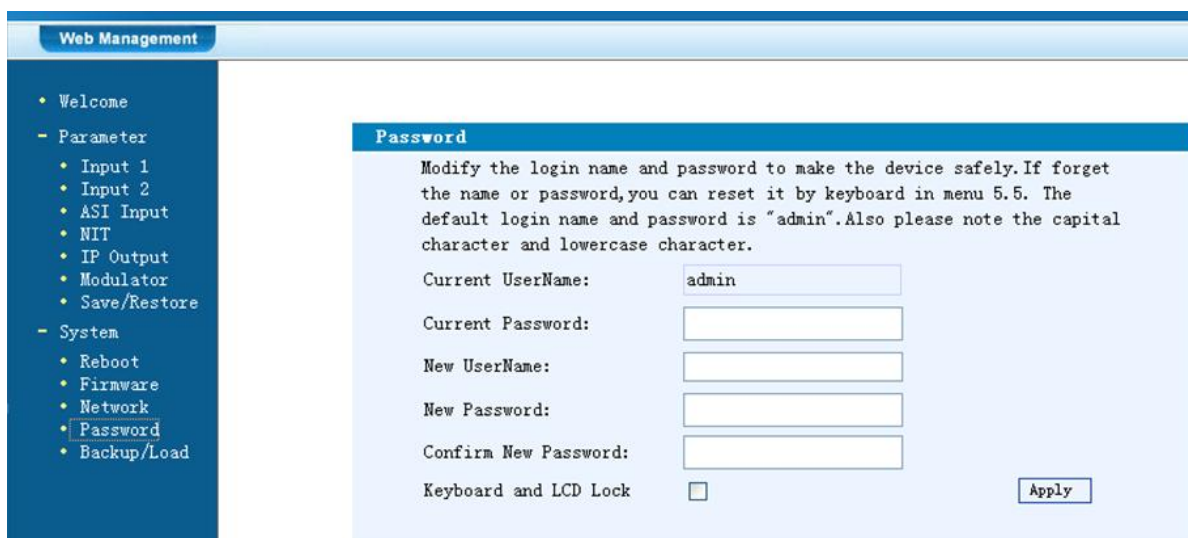

Figure-14

Keyboard and LCD Lock

➤ Keyboard and LCD Lock: If it is marked with “√”, the LCD and keyboard will be locked to avoid unexpected modification or view of the device information and configurations. You can't operate the keyboard & LCD while only the device IP address can be noted in the LCD window.

IP Address
192.168.000.136

Backup/Load

Click “Backup/Load” from the menu, it will display the screen as shown in Figure-15.

Backup Configuration – To back up the device configuration file to a folder

Load Configuration – If you need to load the old configuration to the device, click “Browse” and find the backup configuration file path. After selecting the file, click “Load File” to load the backup file to the device.

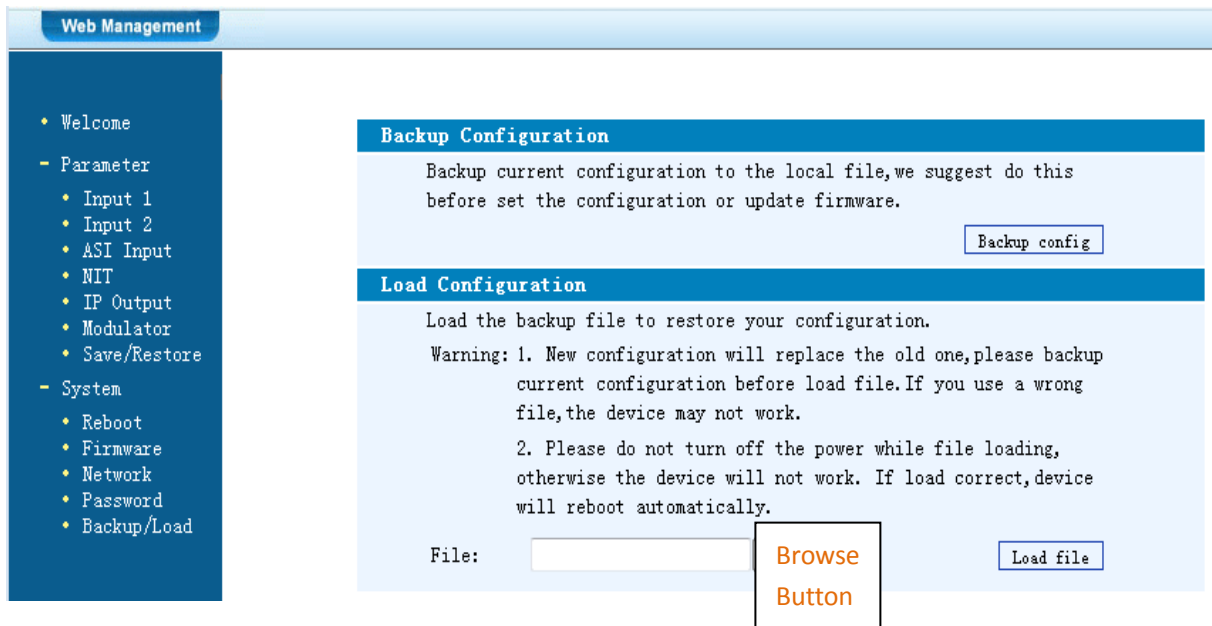
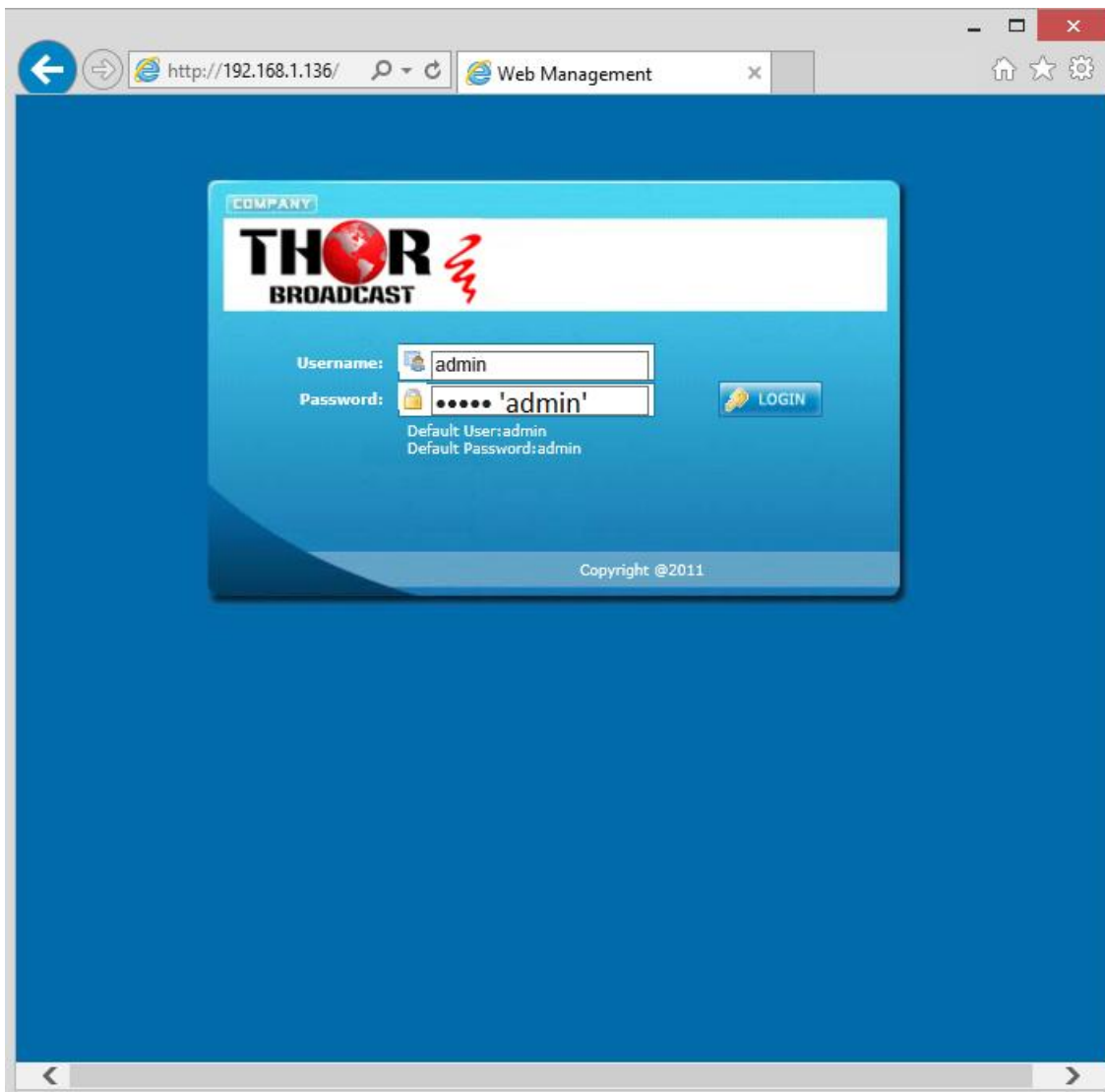

Figure-15



Encoder Modulator Quick Setup with Gui & VCT



Intro – Gui & VCT

Thor Broadcast ships from our facility in Los Angeles with a preloaded NMS GUI firmware
 Generally the IP address will be 192.168.0.136 : this goes into any internet browser URL line
 Once you're at the login screen default username and admin passwords are both: admin

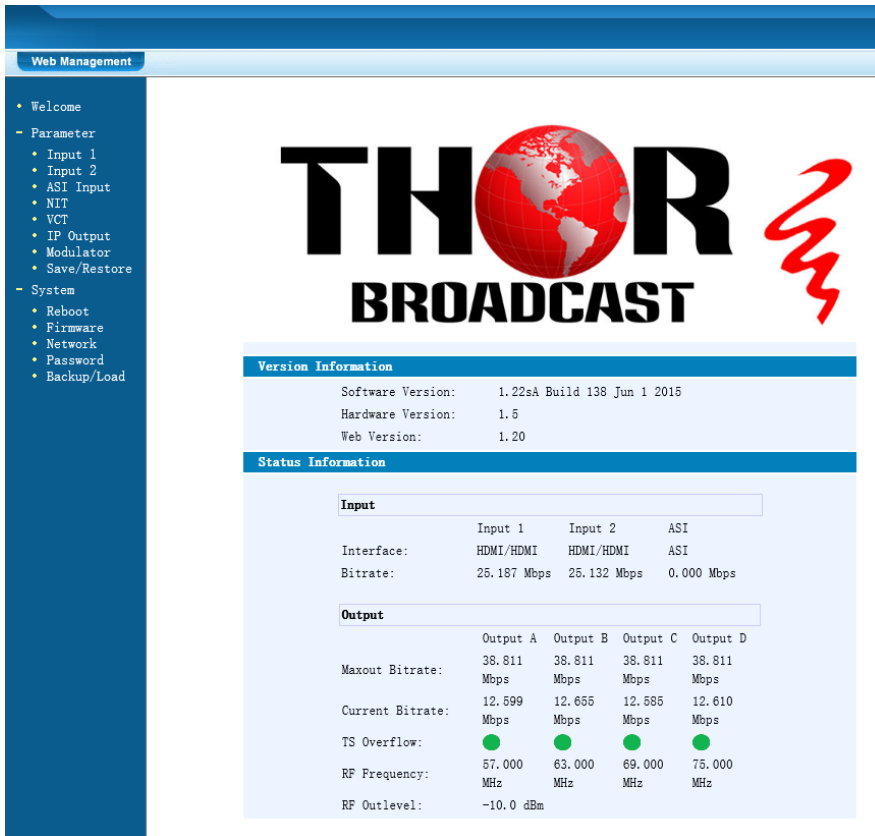

Version Information	
Software Version:	1.22sA Build 138 Jun 1 2015
Hardware Version:	1.5
Web Version:	1.20

Status Information	
Input	
	Input 1 Input 2 ASI
Interface:	HDMI/HDMI HDMI/HDMI ASI
Bitrate:	25.187 Mbps 25.132 Mbps 0.000 Mbps
Output	
	Output A Output B Output C Output D
Maxout Bitrate:	38.811 38.811 38.811 38.811
	Mbps Mbps Mbps Mbps
Current Bitrate:	12.599 12.655 12.585 12.610
	Mbps Mbps Mbps Mbps
TS Overflow:	● ● ● ●
RF Frequency:	57.000 63.000 69.000 75.000
	MHz MHz MHz MHz
RF Outlevel:	-10.0 dBm

***If you do not have a green light at the bottom of this screen as shown to the left here, that means the unit is not reading the input (red light) which means that your resolution is above or below the units threshold of 720 to 1080 (could be 480 if using composite inputs)

- Welcome
- Parameter
 - Input 1
 - Input 2
 - ASI Input
 - NIT
 - VCT
 - IP Output
 - Modulator
 - Save/Restore
- System
 - Reboot
 - Firmware
 - Network
 - Password
 - Backup/Load

The Welcome Screen show above has general information of your working encoder

On the left hand side you can quickly switch to Thor's Parameters and System Control

Input 1 reflects the first TWO HDMI inputs 1 & 2

Input 2 reflects the next TWO HDMI inputs 3 & 4

In this example – we have inserted 4 HDMI inputs into our unit (DVD/BLURAY)

2CH Mpeg2/H. 264 HD Encoder Configuration (EN20)			
Interface	HDMI	HDMI	
Video Format	Mpeg2	Mpeg2	
Aspect Ratio	Auto	Auto	
Low Delay	Normal	Normal	
CC Switch	CC Off	CC Off	
Video BitRate (Mbps)	18.000	18.000	
DTS Delay	200 (1-500)	200 (1-500)	
GOP Bframe	2 (<=3)	2 (<=3)	
Gop Pframe	4 (<=6)	4 (<=6)	
H. 264 Profile	Main Profile	Main Profile	
H. 264 Level	Level 3.1	Level 3.1	
Auto Config	<input checked="" type="checkbox"/>	<input checked="" type="checkbox"/>	
Resolution	1920*1080_50i	1920*1080_50i	
Audio Format	AC 3	AC 3	
Dialog Normalization	-31 (-31 - -1)dB	-31 (-31 - -1)dB	
Audio Source	Auto	Auto	
Audio BitRate	192 Kbps	192 Kbps	
Audio Gain(0-400%)	100%	100%	
Out Enable (ABCDE)	<input checked="" type="checkbox"/> <input type="checkbox"/> <input type="checkbox"/> <input type="checkbox"/> <input type="checkbox"/>	<input type="checkbox"/> <input checked="" type="checkbox"/> <input type="checkbox"/> <input type="checkbox"/> <input type="checkbox"/>	
Service Provider	TV-Provider	TV-Provider	
Program Name	TV-101	TV-102	
SUB-CHANNEL NUMBER	1	1	
PMT PID	0x100	0x104	
Video PID	0x101	0x105	
Audio PID	0x102	0x106	
PCR PID	0x103	0x107	
Video:			
Video Format:	1280x720 59.94p	1280x720 59.94p	
Encoding:			
Bitrate:	18.741 Mbps	18.741 Mbps	
Rom Version:	1.1.1.100	1.1.1.100	
	<input type="button" value="Help"/>	<input type="button" value="Default"/> <input type="button" value="Apply"/>	

INPUTS 1 & 2

You can see that there are a variety of ways to alter the functions and options using simple drop down menus when perusing the various menu options.

However Thor's unique hardware systems are developed to automate most of these options for you. It's important for you to always save and hit APPLY at the bottom to save the work you've done.

You can set up virtual channels and program ID features as well. At the bottom the green light indicates the unit is operational and digesting the video stream at about 18mb/s.

If you have RED lights, there is a 99% certainty that this problem is related to resolution

If you are setting up an encoder with HDMI cables to STB's or DVD players; your settings screen should resemble the one to the left.

In this example we are converting HDMI to QAM

Audio is embedded – MPEG2 – CC OFF

Bitrate is about 18mb/s which is crystal clear HDTV running from a DVD player

2CH Mpeg2/H.264 HD Encoder Configuration (EN20)

Interface	HDMI	HDMI
Video Format	Mpeg2	Mpeg2
Aspect Ratio	Auto	Auto
Low Delay	Normal	Normal
CC Switch	CC Off	CC Off
Video BitRate(Mbps)	18.000	18.000
DTS Delay	200 (1-500)	200 (1-500)
GOP Bframe	2 (<=3)	2 (<=3)
Gop Pframe	4 (<=6)	4 (<=6)
H.264 Profile	Main Profile	Main Profile
H.264 Level	Level 3.1	Level 3.1
Auto Config	<input checked="" type="checkbox"/>	<input checked="" type="checkbox"/>
Resolution	1920x1080_50i	1920x1080_50i
Audio Format	AC 3	AC 3
Dialog Normalisation	-31 (-31 -- -1)dB	-31 (-31 -- -1)dB
Audio Source	Auto	Auto
Audio BitRate	192 Kbps	192 Kbps
Audio Gain(0-400%)	100%	100%
Out Enable(ABCDE)	<input checked="" type="checkbox"/> <input type="checkbox"/> <input type="checkbox"/> <input type="checkbox"/> <input type="checkbox"/>	<input type="checkbox"/> <input checked="" type="checkbox"/> <input type="checkbox"/> <input type="checkbox"/> <input type="checkbox"/>
Service Provider	TV-Provider	TV-Provider
Program Name	TV-101	TV-102
SUB-CHANNEL NUMBER	1	1
PMT PID	0x100	0x104
Video PID	0x101	0x105
Audio PID	0x102	0x106
PCR PID	0x103	0x107

Video: ● ●
 Video Format: 1280x720 59.94p 1280x720 59.94p
 Encoding: ● ●
 Bitrate: 18.741 Mbps 18.741 Mbps
 Rom Version: 1.1.1.100 1.1.1.100

In this example we are converting HDMI to QAM

Audio is embedded – MPEG2 – CC OFF

Bitrate is about 18mb/s which is crystal clear HDTV running from a DVD player

The next page is a QAM Frequency chart which displays the frequency in megahertz you're converting to a channel ID # --

Below you see that the 4 channels are being tuned to 2,3,4,5 in a consecutive order

- Welcome
- Parameter
 - Input 1
 - Input 2
 - ASI Input
 - NIT
 - VCT
 - IP Output
 - Modulator
 - Save/Restore
- System
 - Reboot
 - Firmware
 - Network
 - Password
 - Backup/Load

Modulator Configuration

RF On (ABCD)	<input checked="" type="checkbox"/> <input checked="" type="checkbox"/> <input checked="" type="checkbox"/> <input checked="" type="checkbox"/>	
Standard	J.83B	
Constellation	256 QAM	
Symbol Rate	5.361	(5.000 - 9.000 Msps)
RF Configuration	Select From List	
RF Frequency A	57.000	(30.000 - 1000.000 MHz)
	57 CH 2	
RF Frequency B	63.000	(30.000 - 1000.000 MHz)
	63 CH 3	
RF Frequency C	69.000	(30.000 - 1000.000 MHz)
	69 CH 4	
RF Frequency D	75.000	(30.000 - 1000.000 MHz)
	75 CH 1	
RF Outlevel	-10.0	(-30.0 - -10.0 dBm)
ASI Out E Bitrate	60.000	(0.000 - 72.000 Mbps)
ASI Output	Output A	



HDMI/SDI-QAM-IPLL

CATV QAM Channel Center Frequency - 54 MHz to 860 MHz

EIA CH.	MHz Center Frequency	EIA CH.	MHz Center Frequency	EIA CH.	MHz Center Frequency
2	57	42	333	87	603
3	63	43	339	88	609
4	69	44	345	89	615
5	79	45	351	90	621
6	85	46	357	91	627
95	93	47	363	92	633
96	99	48	369	93	639
97	105	49	375	94	645
98	111	50	381	100	651
99	117	51	387	101	657
14	123	52	393	102	663
15	129	53	399	103	669
16	135	54	405	104	675
17	141	55	411	105	681
18	147	56	417	106	687
19	153	57	423	107	693
20	159	58	429	108	699
21	165	59	435	109	705
22	171	60	441	110	711
7	177	61	447	111	717
8	183	62	453	112	723
9	189	63	459	113	729
10	195	64	465	114	735
11	201	65	471	115	741
12	207	66	477	116	747
13	213	67	483	117	753
23	219	68	489	118	759
24	225	69	495	119	765
25	231	70	501	120	771
26	237	71	507	121	777
27	243	72	513	122	783
28	249	73	519	123	789
29	255	74	525	124	795
30	261	75	531	125	801
31	267	76	537	126	807
32	273	77	543	127	813
33	279	78	549	128	819
34	285	79	555	129	825
35	291	80	561	130	831
36	297	81	567	131	837
37	303	82	573	132	843
38	309	83	579	133	849
39	315	84	585	134	855
40	321	85	591	135	861
41	327	86	597		



Virtual Channels

In order to create RF QAM Channels without decimal points, or in order to create a virtual channel, Thor Broadcast has a VCT menu option to create such results in your RF QAM Distribution.

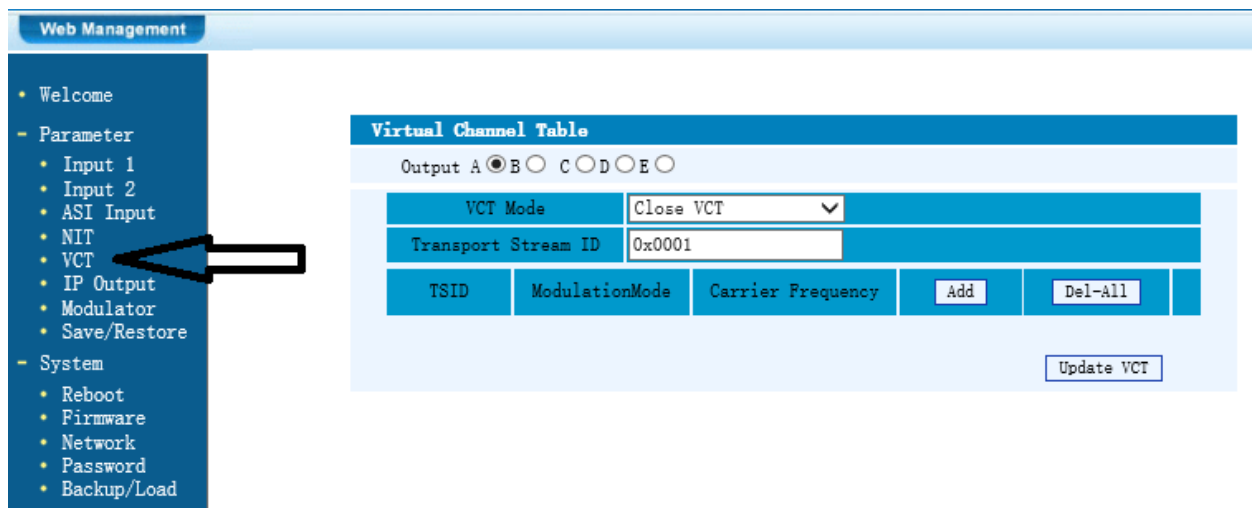

The screenshot shows the 'Web Management' interface. On the left is a navigation menu with the following items:

- Welcome
- Parameter
 - Input 1
 - Input 2
 - ASI Input
 - NIT
 - VCT
 - IP Output
 - Modulator
 - Save/Restore
- System
 - Reboot
 - Firmware
 - Network
 - Password
 - Backup/Load

An arrow points from the 'VCT' menu item to the 'Virtual Channel Table' configuration area. This area includes:

- Output A B C D E
- VCT Mode: (dropdown menu)
- Transport Stream ID:
- Table headers: TSID, ModulationMode, Carrier Frequency
- Buttons: Add, Del-All
- Update VCT button

Since you can only modulate in a direct linear format; such as using channel 10, 11, 12, 13... VCT

Some headend's require a digital remap, some cable companies require different frequencies than channel numbers, and for adding a unit to an existing headend this VCT makes it easy to add any number of channels by using any open frequencies in the RF spectrum and assign simpler format visual channel numbers on your TV set.

EXAMPLE: Suppose you are installing a 4HDMI unit on an existing rack, the client needs to add channels 32, 33, 34, and 7. Frequencies 273, 279, & 285 are clear so adding channels 32, 33, 34 is simple, however in order to add channel 7 we must create a frequency inline for channel 35 (291mhz) and remap to VCT for channel #7 or frequency 177.

First select input 4 or D in the OUTPUT selection

Next click ADD

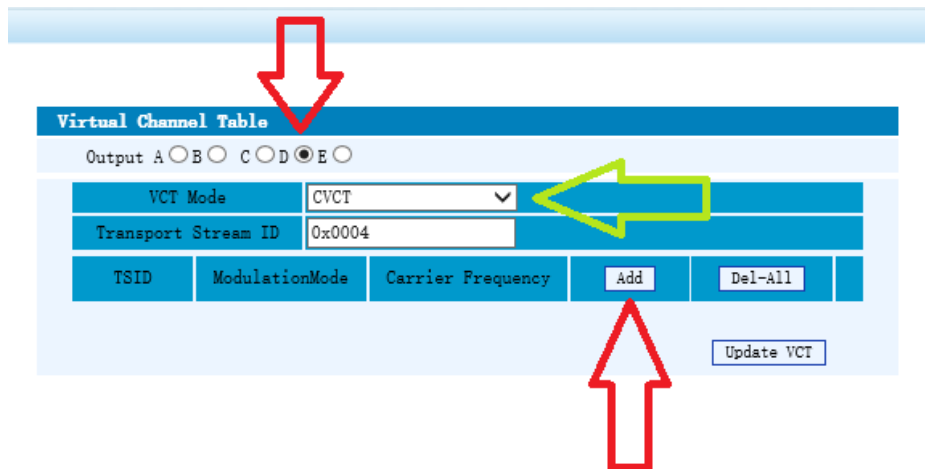

Under VCT MODE: it must be set to CVCT

Next you will see a POP up window

PLEASE MAKE SURE YOU ARE USING MOZILLA, or EXPLORER, generally this firmware does not work well with either google chrome or safari. There is essentially only a few changes that need to be made:

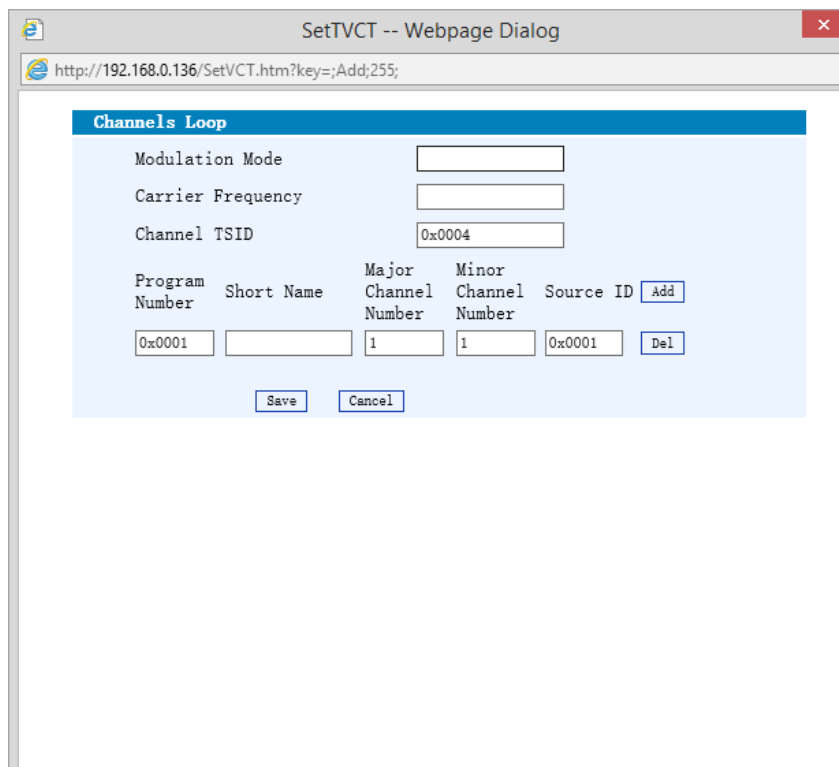

Modulation Mode:
leave blank

Carrier Freq: in this case we are using
Ch 35 or 291mhz

Short Name: optional, in this case
we'll use Blu-Ray

Major CH: This is the first # that you
see on your TV, usually in decimal
format

Minor CH: Number after decimal
following Major CH

So in order to create a whole number without a decimal, all you need to do is put (1008) in the Major Box and then add 7 to the Minor Box. This will create a VCT on frequency 291, but will appear on your RF system as 7. In essence you are creating a virtual channel where there is an empty frequency.

Channels Loop

Modulation Mode	<input type="text" value="0x00"/>				
Carrier Frequency	<input type="text" value="291"/>				
Channel TSID	<input type="text" value="0x0004"/>				
Program Number	Short Name	Major Channel Number	Minor Channel Number	Source ID	<input type="button" value="Add"/>
<input type="text" value="0x0001"/>	<input type="text" value="Blu-Ray"/>	<input type="text" value="1008"/>	<input type="text" value="7"/>	<input type="text" value="0x0001"/>	<input type="button" value="Del"/>

Also make sure to press SAVE to ensure your settings were added correctly.

Now reverting back to your Modulator table, it should look like this:

Modulator Configuration

RF On (ABCD)	<input checked="" type="checkbox"/> <input checked="" type="checkbox"/> <input checked="" type="checkbox"/> <input checked="" type="checkbox"/>	
Standard	<input type="text" value="J. 83B"/>	
Constellation	<input type="text" value="256 QAM"/>	
Symbol Rate	<input type="text" value="5.361"/>	(5.000 - 9.000 Msps)
RF Configuration	<input type="text" value="Select From List"/>	
RF Frequency A	<input type="text" value="273.000"/> <input type="text" value="273 CH 32"/>	(30.000 - 1000.000 MHz)
RF Frequency B	<input type="text" value="279.000"/> <input type="text" value="279 CH 33"/>	(30.000 - 1000.000 MHz)
RF Frequency C	<input type="text" value="285.000"/> <input type="text" value="285 CH 34"/>	(30.000 - 1000.000 MHz)
RF Frequency D	<input type="text" value="291.000"/> <input type="text" value="291 CH 35"/>	(30.000 - 1000.000 MHz)
RF Outlevel	<input type="text" value="-20.0"/>	(-30.0 - -10.0 dBm)
ASI Out E Bitrate	<input type="text" value="60.000"/>	(0.000 - 72.000 Mbps)
ASI Output	<input type="text" value="Output A"/>	

VCT Table should look like this:

Virtual Channel Table					
Output A <input type="radio"/> B <input type="radio"/> C <input type="radio"/> D <input checked="" type="radio"/> E <input type="radio"/>					
VCT Mode		CVCT			
Transport Stream ID		0x0004			
TSID	ModulationMode	Carrier Frequency	Add	Del-All	
0x0004	0x00	291	Detail	Del	
Update VCT					

Now when you fire up the television and begin scrolling through the channel list you'll see our newly created VCT Channel, as shown below 7, 32, 33, & 34

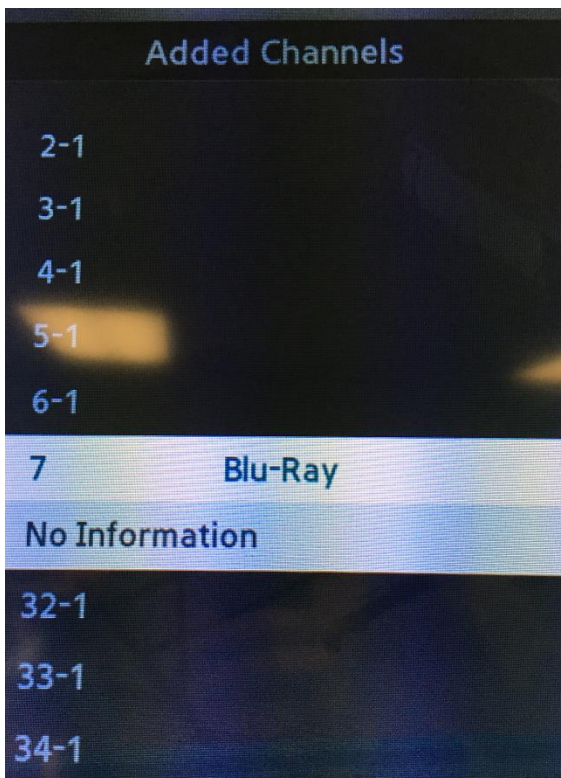

Again this is just an example, but you can see that there is no channel 35, because it has been digitally remapped to appear as channel 7 from Channel 35 or frequency 291.

Also note that because we added a title in – Blu Ray appears by channel # 7 on the TV set channel list

When you are scrolling through the TV channels we notice how under Channel 7 Blu-Ray also appears above it.

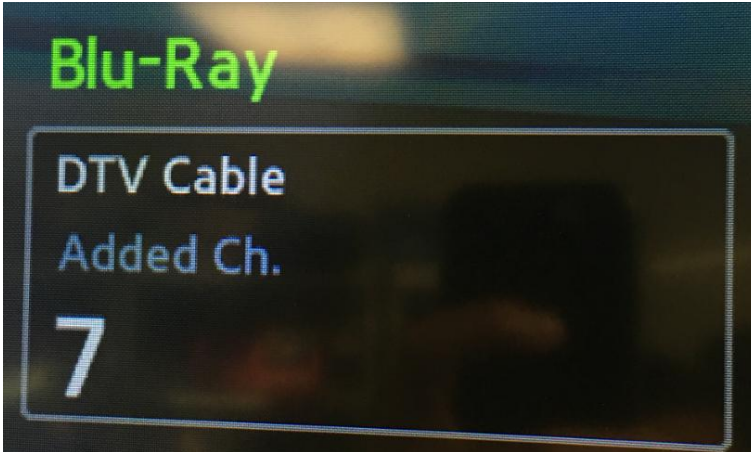

You can ideally set this up for every channel so your customers will always know what they are watching... ABC, FOX, CBS, ESPN

So, after adding in VCT for the other 3 inputs, we can go back to our TV and check the listings to ensure that all 4 HDMI inputs are accounted for.

FIRST always save your work

Click on the SAVE/RESTORE on the left hand menu, then click SAVE CONFIG.

Some notes about these procedures—

- Make sure after your settings are input that you need to ensure that your TV sets are acting in accordance with the changes you're making
- Not every TV set is created equal, some sets will automatically make changes when new lineup situations are addressed, some TV's will pick up the new channels while some legacy TV's will need to be rescanned for QAM channels in the TV setup guide.
- After saving settings on your Thor Encoder, also power cycle the unit as well. This restart helps the unit achieve optimal settings from the onset once changes are made

Once you rescan the TV and your settings on the Thor Encoder/Modulator are definitively correct, you should be able to rescan your TV set (we use Samsung at the Thor Broadcast Lab)

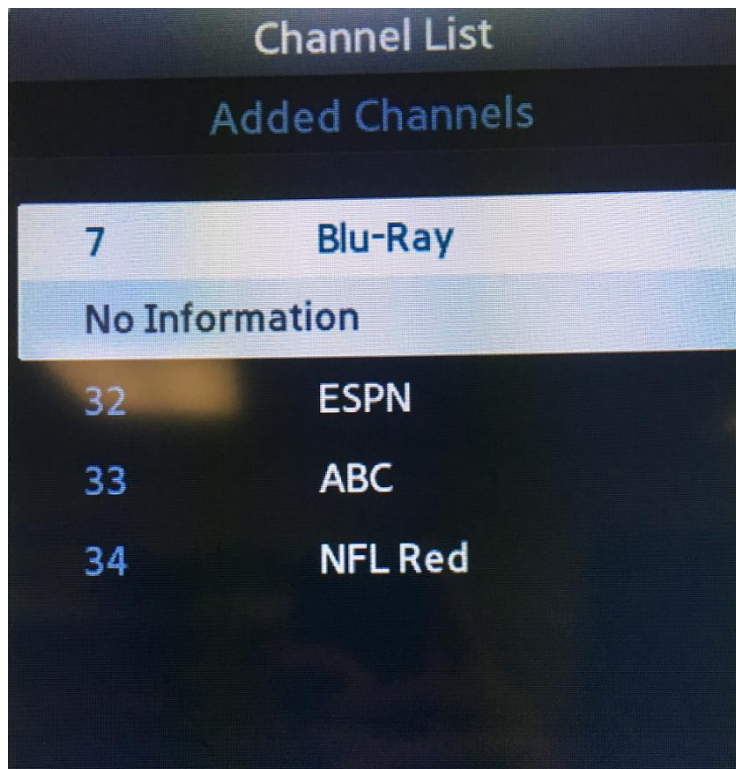

The Thor Modulator is broadcasting on frequencies of 273, 279, 285, & 291.

Using VCT we put CH 35 (freq 291) on Logical Channel # 7

We used the VCT for channels 32, 33, & 34 to eliminate decimal points and to label the channels accordingly with the faux labels in this example being ESPN, ABC, and NFL Redzone.

Also note that after you rescan your QAM tuner in your TV set, it eliminated all the other channels that we're not broadcasting (image from pg 9)

Now that you've completed these steps and confirmed everything is functioning as it should, you should now introduce this encoder to the rest of the RF QAM distribution headend by using the RF output from the Thor H-4ADHD via coax to the rest of the modulators using a combiner already found on the rack inside the headend room of the facility.



[Encoder Modulator IPTV Setup](#)

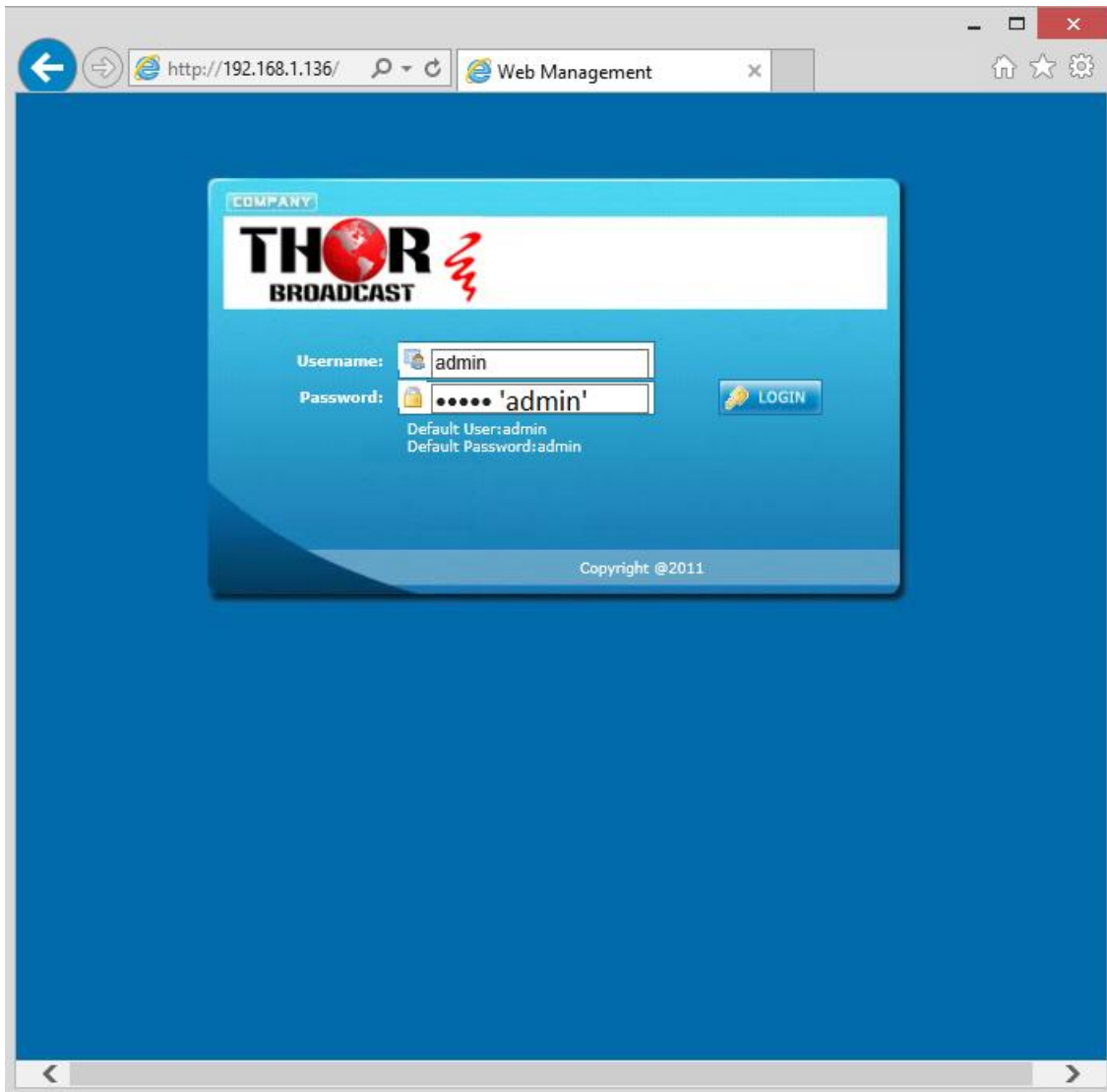

Intro

Thor Broadcast ships from our facility in Los Angeles with a preloaded NMS GUI firmware
 Generally the IP address will be 192.168.0.136 ; this goes into any internet browser URL line
 Once you're at the login screen; default username and admin passwords are both: admin
 Here we changed the IP on the units front panel to 192.168.1.136 to match the PC's nic.

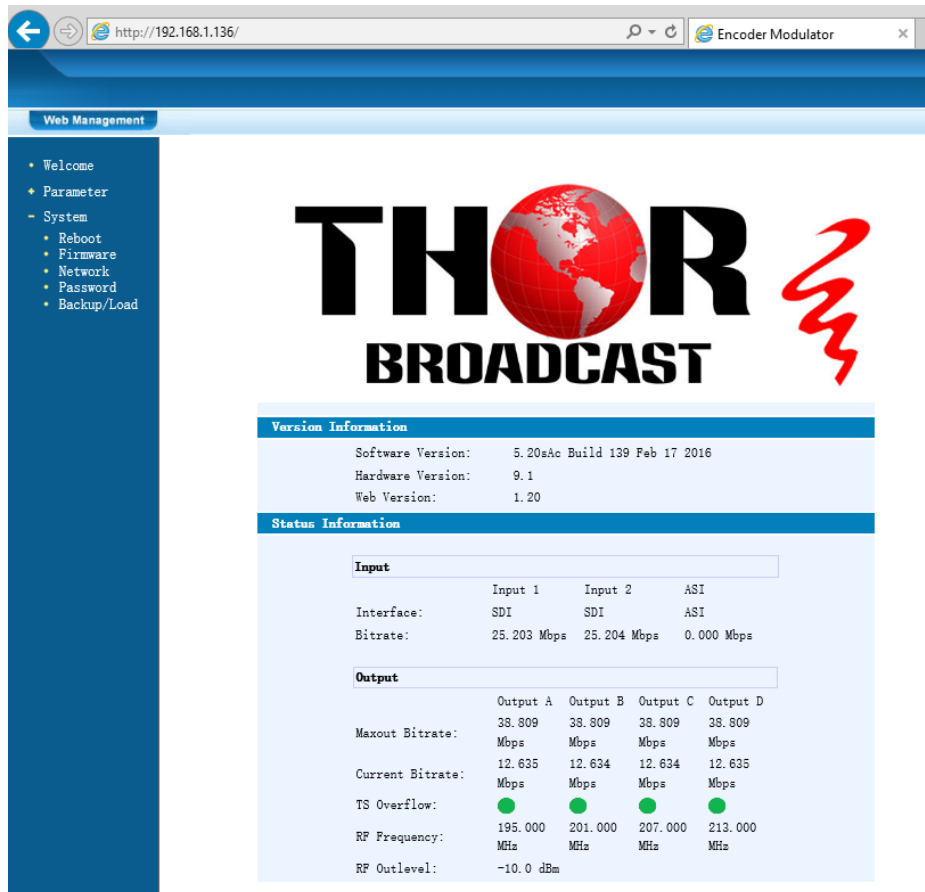

***If you do not have a green light at the bottom of this screen as shown to the left here, that means the unit is not reading the input (red light) which means that your resolution is above or below the units threshold of 720 to 1080 (could be 480 if using composite inputs)

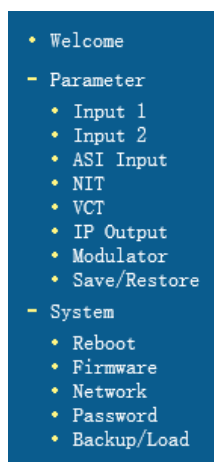

The Welcome Screen above has general information of your operating encoder

On the left hand side you can quickly switch to Thor's Parameters and System Control

Input 1 reflects the first TWO HDSDI inputs 1 & 2

Input 2 reflects the next TWO HDSDI inputs 3 & 4

In this example – we have inserted 4 HD-SDI inputs into our unit

2CH Mpeg2/H.264 HD Encoder Configuration (EN14)			
Video Format	Mpeg2	Mpeg2	Mpeg2
Aspect Ratio	Auto	Auto	Auto
Low delay	Normal	Normal	Normal
Video Cache Bypass	Enable	Enable	Enable
CC Switch	EIA 708	EIA 708	EIA 708
Video BitRate(Mbps)	12.000	12.000	12.000
DTS Delay	200 (1-500)	200 (1-500)	200 (1-500)
GOP Bframe	2 (<=3)	2 (<=3)	2 (<=3)
Gop Pframe	4 (<=6)	4 (<=6)	4 (<=6)
H.264 Profile	Main Profile	Main Profile	Main Profile
H.264 Level	Level 3.1	Level 3.1	Level 3.1
Auto Config	<input checked="" type="checkbox"/>	<input checked="" type="checkbox"/>	<input checked="" type="checkbox"/>
Resolution	1920*1080_50i	1920*1080_50i	1920*1080_50i
Audio Format	Mpeg2	Mpeg2	Mpeg2
Dialog Normalization	-31 (-31 - -1)dB	-31 (-31 - -1)dB	-31 (-31 - -1)dB
Audio BitRate	192 Kbps	192 Kbps	192 Kbps
Audio Gain(0-400%)	100%	100%	100%
Program Out Enable (ABCDE)	<input checked="" type="checkbox"/> <input type="checkbox"/> <input type="checkbox"/> <input type="checkbox"/> <input type="checkbox"/>	<input type="checkbox"/> <input checked="" type="checkbox"/> <input type="checkbox"/> <input type="checkbox"/> <input type="checkbox"/>	<input type="checkbox"/> <input checked="" type="checkbox"/> <input type="checkbox"/> <input type="checkbox"/> <input type="checkbox"/>
Service Provider	TV-Provider	TV-Provider	TV-Provider
Program Name	TV-101	TV-102	TV-102
SUB-CHANNEL NUMBER	0x1	0x2	0x2
PMT PID	0x100	0x104	0x104
Video PID	0x101	0x105	0x105
Audio PID	0x102	0x106	0x106
PCR PID	0x103	0x107	0x107
Video:			
Video Format:	1920x1080 59.94i	1920x1080 59.94i	1920x1080 59.94i
Encoding:			
Bitrate:	12.604 Mbps	12.658 Mbps	12.658 Mbps
Rom Version:	5.8.1.100	5.8.1.100	5.8.1.100
<input type="button" value="Help"/>		<input type="button" value="Default"/> <input type="button" value="Apply"/>	

INPUTS 1 & 2 for HD-SDI (2 channels)

You can see that there are a variety of ways to alter the functions and options using simple drop down menus when perusing the various menu options.

However Thor's unique hardware systems are developed to automate most of these options for you. It's important for you to always save and hit APPLY at the bottom to save the work you've done.

You can set up virtual channels and program ID features as well.

At the bottom the green light indicates the unit is operational and digesting the video stream at about 12.5mb/s.

If you have RED lights, there is a 99% certainty that this problem is related to resolution.

The drop down menus offer an abundance of options, here we have standardized the unit to ingest HD-SDI video and to encode those streams in MPEG2 with EIA Closed Captions 708 embedded on the SDI.

These are just a few of the drop down menu options you can manipulate in the NMS gui

The screenshot shows the configuration interface for a 2CH Mpeg2/H.264 HD Encoder. The interface is divided into two columns for channel configuration. Callouts point to the following dropdown menus:

- Encoding Format:** Mpeg2, H.264
- Aspect Ratio:** Auto, 4:3, 16:9
- Latency Mode:** Normal, Mode 1, Mode 2, Manual
- Closed Caption:** EIA 608, EIA 708
- Resolution:** 1920*1080_60i, 1920*1080_50i, 1440*1080_60i, 1440*1080_50i, 1280*720_60p, 1280*720_50p, 720*480_60i, 720*576_50i
- Auto-Resolution:** 1920*1080_50i
- Audio Codec:** Mpeg2, Mpeg2 AAC, Mpeg4 AAC, AC 3
- Program Streams:** A set of five checkboxes, with the second one checked.

While the unit will automate many options and tune to ideal settings when first powered on, there are still numerous options inherently available for your fine tuning including bit rate and latency.

Once you have selected your options we will turn our attention to the 5 boxes next to program streams.

These boxes are defined as A B C D E

A B C D are your 4 HD-SDI input signals and E is for Multiplexing on ASI and IP output(MPTS)

You'll find these on the **IP Output** **Modulator** menus as well, these check marks indicate where

your streams will be output in the IP and Modulator sections, but in the **Input 1** **Input 2** menu's this is where you activate those streams for encoding, if these boxes are left unchecked, this will disallow any programs from being output



HDMI/SDI-QAM-IPLL

Input 1: Program Out Enable (ABCDE) Here A & B are on

Input 2: Program Out Enable (ABCDE) Here C & D are on

Together all output streams are on and transmitting all inputs A B C D or 1, 2, 3, & 4.

Now when you click on the IP Out button on the main menu **IP Output** you'll see the boxes again

IP Output Configuration

IP Output Enable(1/2/3/4/M):

Filter Null Pkt(1/2/3/4/M):

SPTS1	<input type="text" value="224.2.2.2"/>	Port: <input type="text" value="2234"/>	Protocol: <input type="text" value="UDP"/>	TTL: <input type="text" value="128"/>
SPTS2	<input type="text" value="224.2.2.2"/>	Port: <input type="text" value="2236"/>	Protocol: <input type="text" value="UDP"/>	TTL: <input type="text" value="128"/>
SPTS3	<input type="text" value="224.2.2.2"/>	Port: <input type="text" value="2238"/>	Protocol: <input type="text" value="UDP"/>	TTL: <input type="text" value="128"/>
SPTS4	<input type="text" value="224.2.2.2"/>	Port: <input type="text" value="2240"/>	Protocol: <input type="text" value="UDP"/>	TTL: <input type="text" value="128"/>
MPTS	<input type="text" value="224.2.2.2"/>	Port: <input type="text" value="2242"/>	Protocol: <input type="text" value="UDP"/>	TTL: <input type="text" value="128"/>
Service IP:	<input type="text" value="192.168.2.137"/>			
Subnet Mask:	<input type="text" value="255.255.255.0"/>			
Gateway:	<input type="text" value="192.168.2.0"/>			

Above you can see all boxes are checked and outputting IP on Multicast for both SPTS and MPTS

If you were to uncheck boxes 1&2 IP Output Enable(1/2/3/4/M): then in this scenario you will only be outputting HDSDI inputs 3 and 4 in IP

Having this kind of flexibility allows you to output channels in RF or IP in any format (Mpeg2, H.264)

For example you can input the same SDI video source in inputs 1&2 and encode them separately in two different formats so you can output the same video in Mpeg2 on RF and H.264 in IP simultaneously at the same latency so your viewers can see the video regardless if it's on TV or a PC.

Current Protocol options in the drop down are as shown:

Another important element here is to ensure the NMS gui is not on the same subnet as the DATA port. So if you can recall we used 192.168.1.136 for NMS, above you see we used 192.168.2.137 for IP out. If you do not put them on different subnets there will be IP collisions and neither will work correctly.

To check your work and make sure your SPTS or MPTS is streaming, a simple easy way to test your stream is to use some freeware found on the internet.

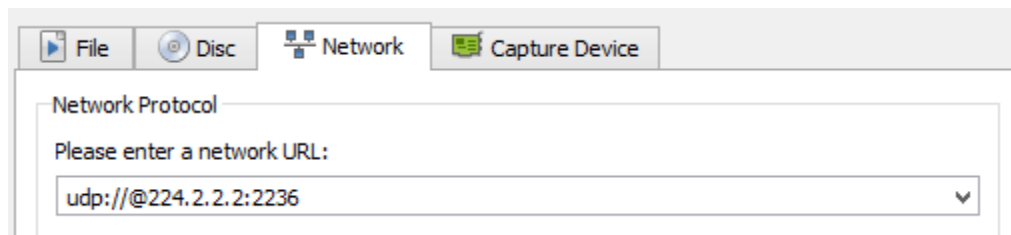

Here we are testing out SPTS #2, you can see below it matches port 2236

SPTS1	<input type="text" value="224.2.2.2"/>	Port: <input type="text" value="2234"/>	Protocol: <input type="text" value="UDP"/>	TTL: <input type="text" value="128"/>
SPTS2	<input type="text" value="224.2.2.2"/>	Port: <input type="text" value="2236"/>	Protocol: <input type="text" value="UDP"/>	TTL: <input type="text" value="128"/>
SPTS3	<input type="text" value="224.2.2.2"/>	Port: <input type="text" value="2238"/>	Protocol: <input type="text" value="UDP"/>	TTL: <input type="text" value="128"/>
SPTS4	<input type="text" value="224.2.2.2"/>	Port: <input type="text" value="2240"/>	Protocol: <input type="text" value="UDP"/>	TTL: <input type="text" value="128"/>
MPTS	<input type="text" value="224.2.2.2"/>	Port: <input type="text" value="2242"/>	Protocol: <input type="text" value="UDP"/>	TTL: <input type="text" value="128"/>

Right away the testing image has begun scrolling, in this case our test generator was color bars



For Further Tech Support

1-800-521-Thor(8467)

support@thorfiber.com

Chapter 5 - Troubleshooting

THOR's ISO9001 quality assurance system has been approved by the CQC organization. We guarantee the products' quality, reliability and stability. All THOR products have passed all testing and manual inspections before they are shipped out. The testing and inspection scheme already covers all the Optical, Electronic and Mechanical criteria which have been published by THOR. To prevent a potential hazard, please strictly follow the operation conditions.

Prevention Measures

- Installing the device in a place where the environmental temperature is between 0 to 45 °C
- Making sure the unit has plenty of ventilation for the heat-sink on the rear panel; and other heat-sink bores if necessary
- Checking the AC input within the power supply and ensure it is working, the connection is correctly installed before switching on device
- Checking the RF output levels to stay within a tolerable range, if it is necessary
- Checking all signal cables have been properly connected
- Frequently switching on/off device is prohibited; the interval between every switching on/off must be greater than 10 seconds.

Conditions needed to unplug power cord

- Power cord or socket damage.
- Any liquid that got into the device.
- Any stuff that could cause a circuit short
- Device in damp environment
- Device has suffered from physical damage; i.e. it fell off a rack.
- Longtime idle.
- After switching on and restoring to factory setting, device still won't work properly.
- Maintenance needed on device



Chapter 6 -Packing List

Thor Broadcast SDI/HDMI Encoder Modulator	1PC
User's Manual CD	1PC
HDMI/SDI Cables	1-4 PCS
Power Cord	1PC

Chapter 7 - Application

7.1 Application Example

1). Residences and Private Homes Video content DVB-T/ISDB-T distribution

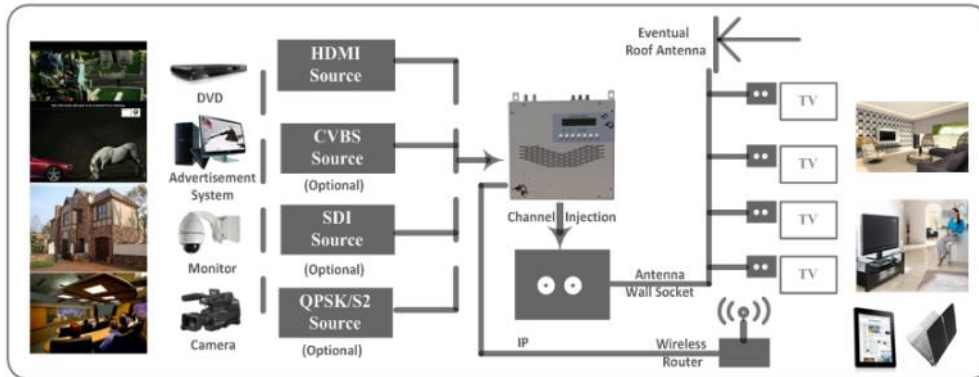

2) Outside Audio-Video contents ON-AIR DVB-T/ISDB-T distribution

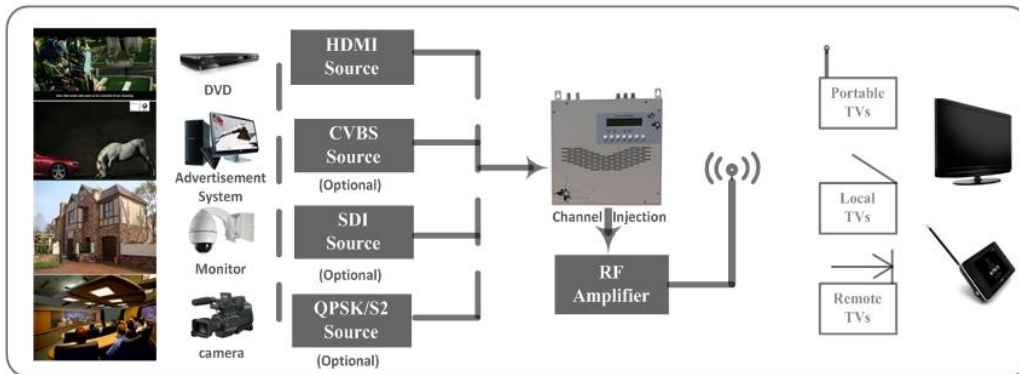

3) Hotel Audio-Video contents DVB-T/ISDB-T distribution

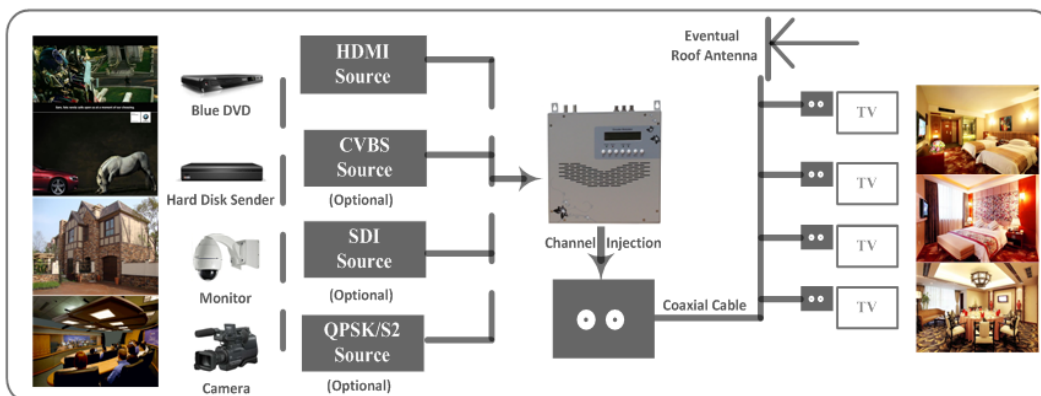

4) Bar Audio-Video contents distribution

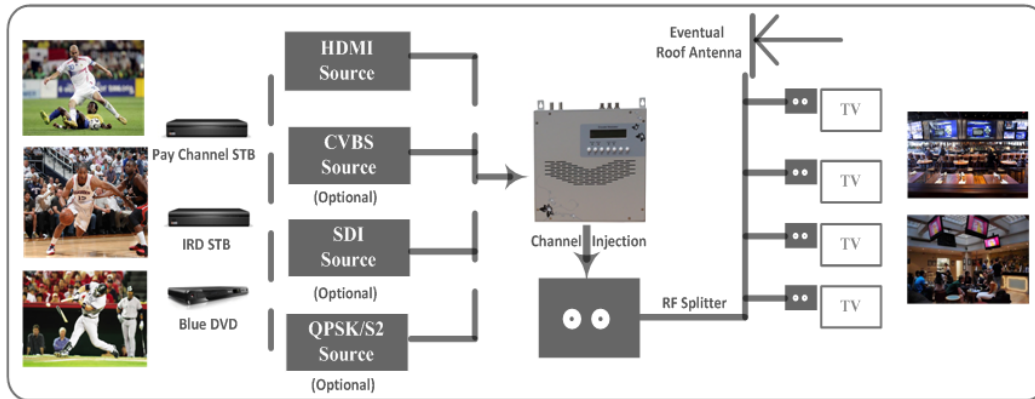

5) Cinema Audio-Video contents DVB-T/ISDB-T distribution

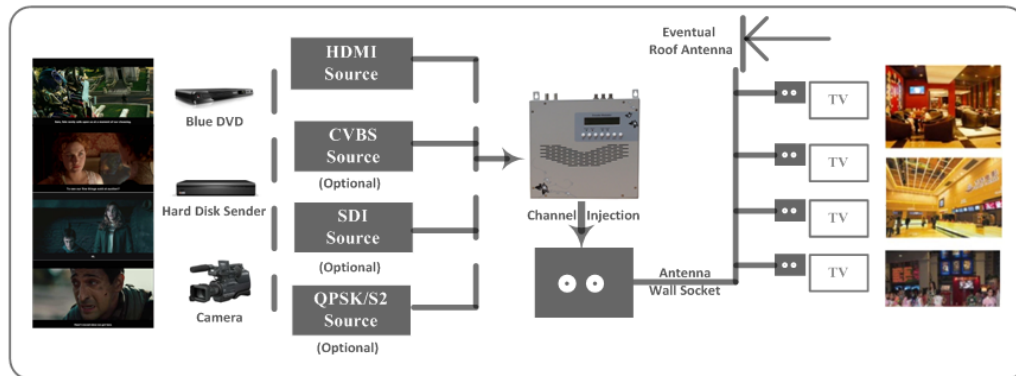

6) Company Audio - Video contents distribution

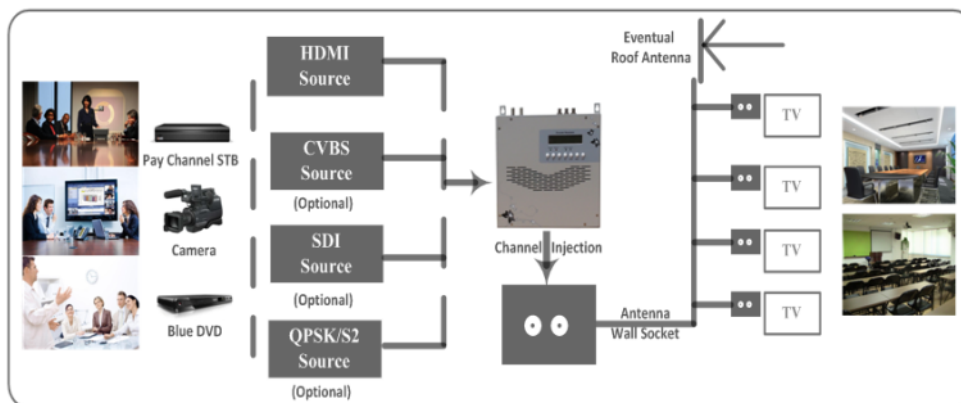

APPENDIX**INTERNAL TEST REPORT OF DELAY**

(The values of average latency cover the progress from Encoding to Decoding.)

Decoding Terminal	Encoding Details					Average Delay (ms)
	Single Source Interface	Bit Rate Mode	Resolution	Low Delay Mode	Encoding Type	
DVB-C HD STB	CVBS	VBR	576i@50	Mode 1	mpeg2	310
					H.264	225
				Mode 2	mpeg2	430
					H.264	440