

THOR

FIBER

H-AC3-CMOD-QAM-LL

Single Channel HDMI

Encoder/Modulator



A Note from Thor About This Manual

Intended Audience

This user manual has been written to help people who have to use, integrate and to install the product. Some chapters require some prerequisite knowledge in electronics and especially in broadcast technologies and standards.

Disclaimer

No part of this document may be reproduced in any form without the written permission of Thor Broadcast.

The contents of this document are subject to revision without notice due to continued progress in methodology, design and manufacturing. Thor shall have no liability for any error or damage of any kind resulting from the use of this document.

Copy Warning

This document includes some confidential information. Its usage is limited to the owners of the product that it is relevant to. It cannot be copied, modified, or translated in another language without prior written authorization from Thor Broadcast.

Directory

CHAPTER 1.....	4
Introduction	4
General Description	4
Principle Drawing	5
CHAPTER 2.....	7
Safety Instruction and Installation	7
Safety Instructions.....	7
Installation.....	8
Operation and Management.....	12
Chapter 4.....	18
Record TS and Play TS through USB Disk.....	18
Appendix	21

CHAPTER 1

Introduction

General Description

The Thor H-AC3-CMOD-QAM-LL encoder & modulator is a portable part of the popular CMOD series of digital HDTV encoder modulator systems formally known as VQAM. Like all CMOD systems, this platform is available in three versions for use with over 95% of the world's broadband TV systems. Advances in technology have reduced component size to the scale that Thor can now integrate every system and component necessary for a digital HDTV headend into a single handheld unit. CMOD systems are combination devices that bundle a real time MPEG hardware encoder, DTV transport stream generator, and agile RF frequency modulator in a single enclosure. Any HDMI live video source can now be converted to an open TV channel for insertion and distribution over cable & antenna TV coax systems. The generated program can be viewed natively on any television set with its built in tuner.

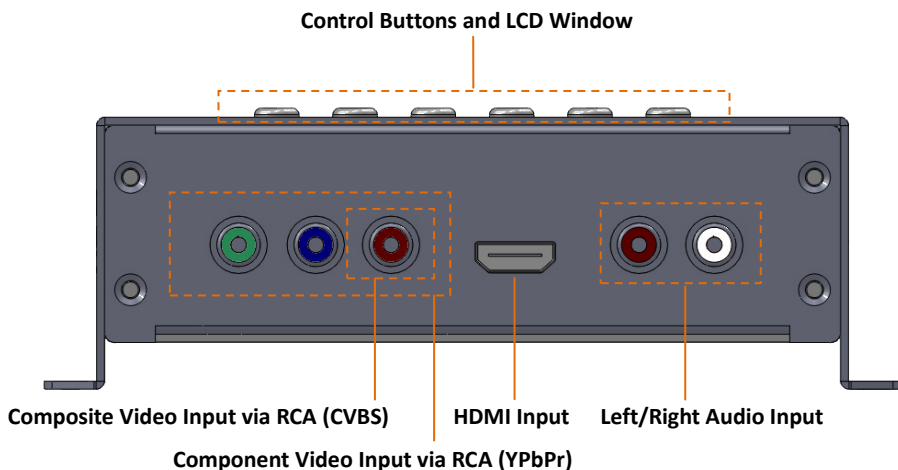

THOR

H-AC3-CMOD-QAM-LL

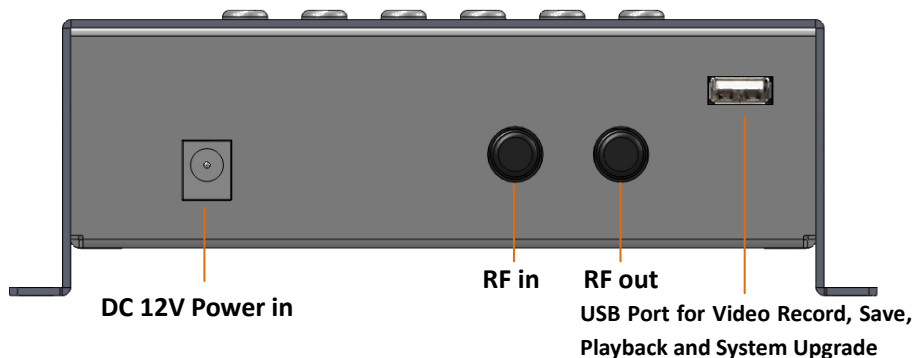

Principle Drawing

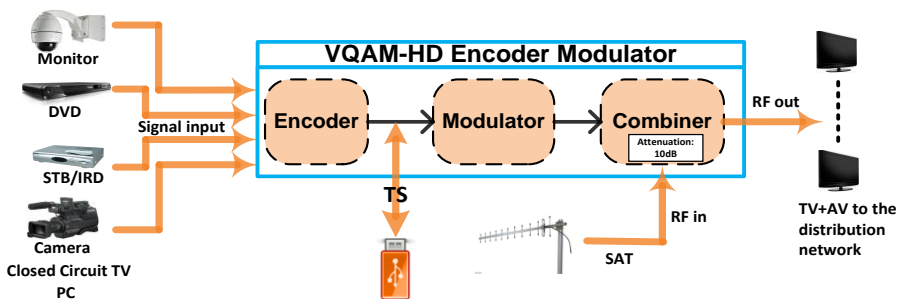

THOR

H-AC3-CMOD-QAM-LL

Encoding Section			
HDMI	Video	Encoding	MPEG-2, MPEG-4 AVC/H.264
		Interface	HDMI*1
		Resolution	1920*1080_60P,1920*1080_50P → (for MPEG-4 AVC/H.264 only) 1920*1080_60i, 1920*1080_50i; 1280*720_60p, 1280*720_50P
		Bit rate	1.000~19.000 Mbps
	Audio	Encoding	MPEG1 Layer II, MPEG2-AAC, MPEG4-AAC, Dolby Digital
		Interface	HDMI
		Sample rate	48KHz
		Bit rate	64, 96,128, 192, 256, 320, 384kbps
YPbPr/ CVBS	Video	Encoding	MPEG-2, MPEG-4 AVC/H.264
		Interface	CVBS *1, YPbPr*1
		Resolution	CVBS: 720x576_50i (PAL);720x480_60i (NTSC) YPbPr: 1920*1080_60i, 1920*1080_50i;1280*720_60p, 1280*720_50P
		Bit rate	1.000~19.000 Mbps
	Audio	Encoding	MPEG1 Layer II, MPEG2-AAC, MPEG4-AAC
		Interface	1*Stereo /2 mono
		Sample rate	48KHz
		Bit rate	64, 96,128, 192, 256, 320, 384kbps
Modulator Section			
Standard	J.83A (DVB-C)	J.83B	J.83C
Constellation	16/32/64/128/256QAM	64/ 256QAM	64/ 256QAM
Bandwidth	8M	6M	6M
MER	≥43dB		
RF frequency	30~960MHz, 1KHz step		
RF output level	-16~ -36dbm(71~91 dbμV), 0.1db step		
Symbol rate	5000-9000 Ksps		
System			
Management	Local control: LCD + control buttons		
Language	English		
LCN Insertion	yes		
General			
Power supply	DC 12V		
Dimensions	144*238*52mm		

Weight	Approx 1kg
Operation temperature	0~45°C

CHAPTER 2

Safety Instruction and Installation

Safety Instructions



WARNING:To prevent fire or electrical shock, do not expose the device to rain or moisture.

✘ The encoder modulator is powered with a voltage of 12VDC. Please do not use with any other power source or it can cause serious harm to the unit and will void the warranty provided by Thor Fiber.

✘ Therefore: Follow these simple rules

- Do not replace power supply with a voltage greater than 12VDC.
- Do not connect the device to the power unit if the power cord is damaged.
- Do not plug the device into anything until it has been correctly installed
- Do not cut the cord.



Avoid placing the device next to central heating components and in areas of high humidity.

Do not cover the device with elements that obstruct the ventilation slots.

If the encoder modulator has been kept in cold conditions for a long time, keep it in a warm room for a minimum of 2 hours before plugging it into a socket.

Mount the device in a vertical position with the connectors located on the top side.

If replacement parts are required, be sure the service technician has used replacement parts specified by Thor. Unauthorized substitutes may result in fire, electric shock or other hazards.

Safety check- Upon completion of any service or repairs to this device, ask the service technician to perform safety checks to determine that the device is in proper condition.

THOR

H-AC3-CMOD-QAM-LL

Installation



Follow these simple steps to avoid damaging the unit

Do not open the unit. Do not connect the unit to the powersupply before or during assembly. Connect the unit as shown below



5 Steps for Success

1. Mount and tighten the screws and plugs to secure the unit to the wall. Leave 10 cm of free space around from each unit.
2. Connect the signal input in the respective connectors. The signal source can be from a surveillance monitor, DVD, set-top box, CCTV and etc.
3. Optionally, connect the loop-through RF input coaxial cable.
4. Connect cable to RF output to STB/TV.
5. Powersupply connection: a) Connect the earth cable; b) Connect the power plug to

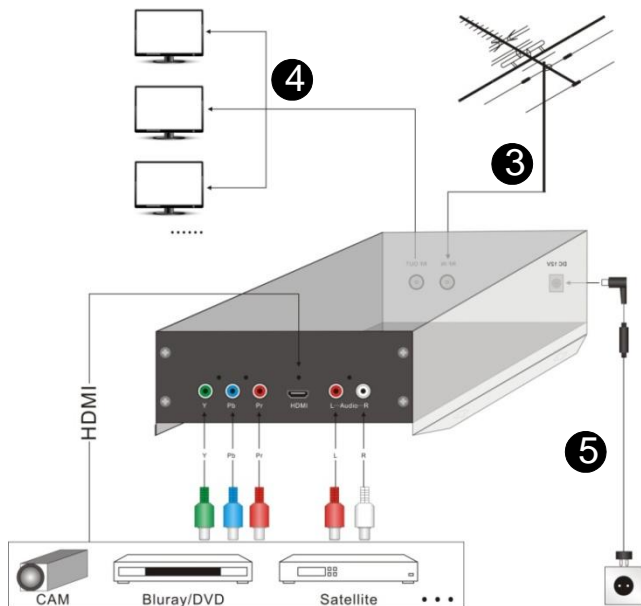

THOR

H-AC3-CMOD-QAM-LL

the unit mains connector; c)
Connect the power plug to
the socket.

Cascade Installation

H-AC3-CMOD-QM-LL unit has 1 TV signal to RFoutput encoded as DVB-C DigitalTV signal.

Several units can be cascaded in order to increase the capacity. The maximum capacity of a series of N units is 1xN. You can stack as many inputs as you like and use the loop out feature or for larger installations you can also use a combiner.

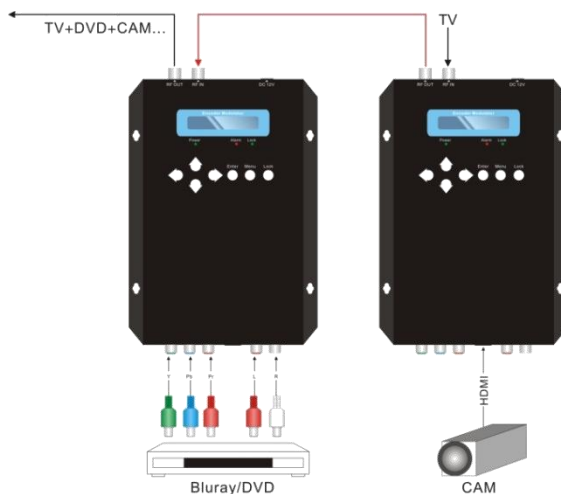

THOR

H-AC3-CMOD-QAM-LL

USB Recorder & Player



TS Recorder and Save:

Thor can encode the source video to *.ts files and save them through the USB flash drive.

- Connect the signal source to Thor and start encoding process.

- Start the record process and save the TS generated to the USB flash drive.

*.ts Video Creation Software:

Users can also create *.ts videos containing pictures, videos and music with our creator software on a PC and save them into the USB flash drive.

- Drag the files to "Creator" application.
Formats supported include:
Image: JPG, PNG, BMP, GIF
Audio: MP3, WAV
Video: WMV, MPG, MP4, TS, AVI...

- Start the conversion process to generate *.ts videos



TS Playback:

- Insert the USB flash drive with *.ts videos and play back the content in an easy way.

- A single video can be up to 2G in size and multi videos can be played on a loop.



USB Flash Drive Specifications Required:

- Standard: High Speed 2.0
- File System: FAT 32
- Memory: 32G is suggested

CHAPTER 3

Operation and Management

H-AC3-CMOD-QM-LL is controlled and managed through the key board and LCD display.



LCD Display –It presents the selected menu and the parameter settings. The backlight in the display is on when the power source is plugged in.

LED –These lights indicate the status of the unit

- Power: It lights on when the power supply is connected.
- Alarm: It lights on when there is an error, such as signal loss.
- Lock: It lights on when the signal source connected and goes off when the signal is lost.

Left/Right/Up/Down buttons –Use these buttons to turn the screen pages, shift the target items by moving the triangle, or change the parameter settings in the program mode.

Enter –Use this button to enter a submenu or save a new setting after adjustment; press it to start adjusting the value of certain items with Up/Down buttons when the corresponding underline flash;

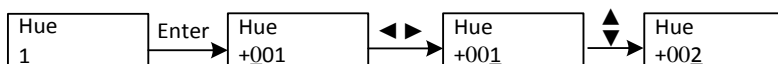

Press it to activate the hidden selections and change the setting with Up/Down (or Left/Right) buttons.

THOR

H-AC3-CMOD-QAM-LL

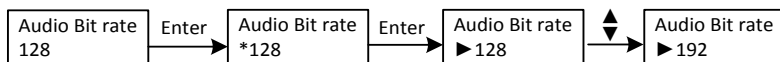

Menu –Press this button to step back

Lock –Locking the screen / cancelling the lock state, and entering the main menu after the initialization of the device. After pressing lock key, the system will question the users to save present setting or not. If not, the LCD will display the current configuration state.

When the power is connected, the LCD will start to initialize the program. The LCD menu goes as below chart.

THOR

H-AC3-CMOD-QAM-LL

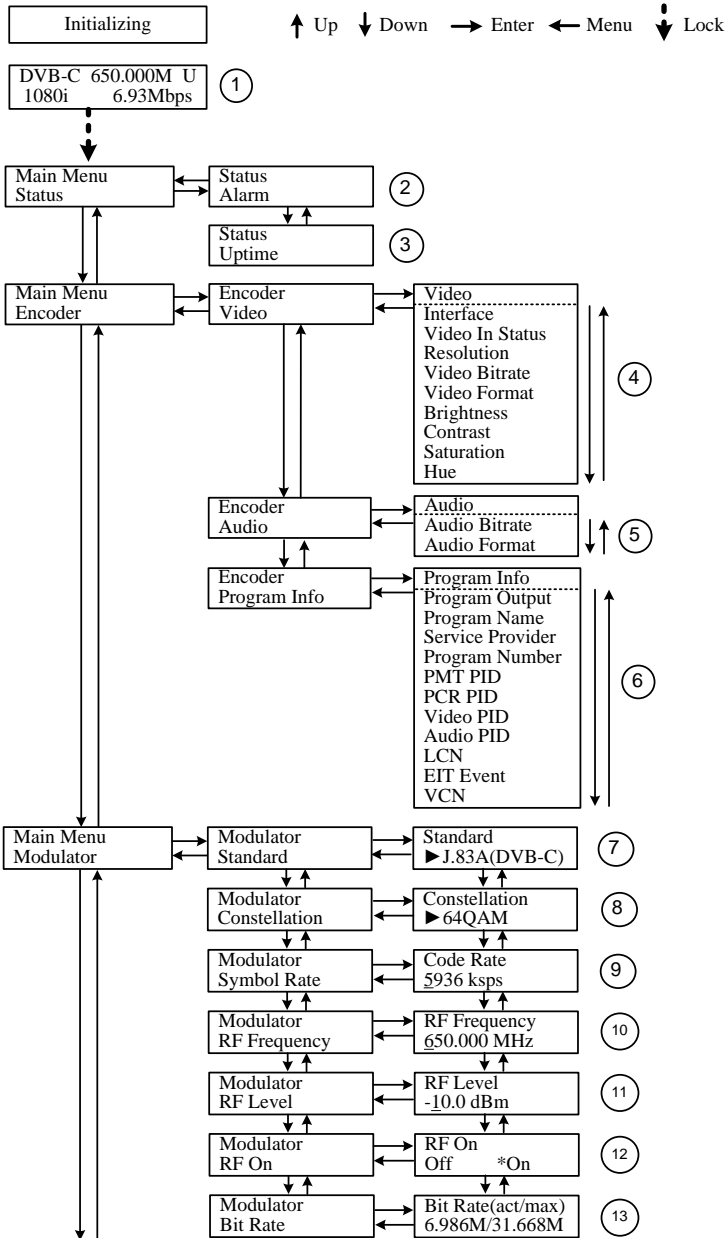

THOR

H-AC3-CMOD-QAM-LL

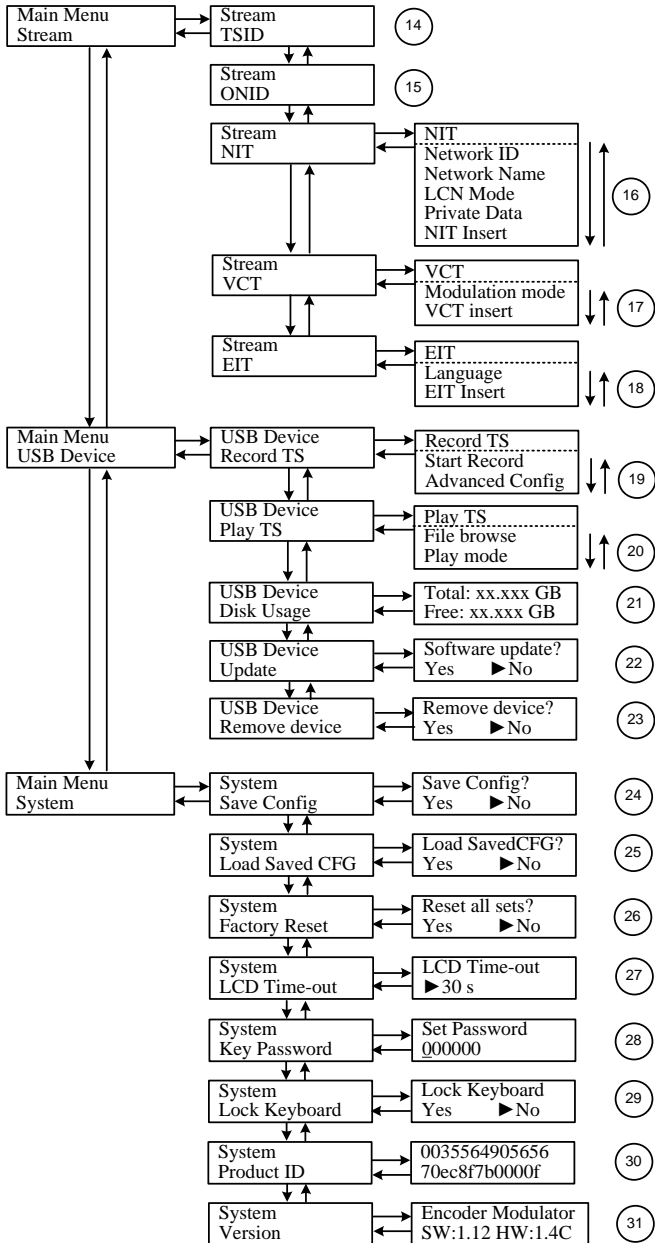



H-AC3-CMOD-QAM-LL

1) DVB-C: modulating standard; XX.XXX MHz: the current output frequency; U: symbol of the USB disk insertion; 1080i: video resolution of signal source; X.XX Mbps: the current encoding bit rate

2) Alarm Status: For example, if the signals lost, it will give alarm and display error type under this menu. For example: *Video 1 Not Lock*

3) Uptime: It displays the working time duration of the device. It times upon powering on.

4) Video Parameters: User can enter the items respectively to set video parameters. **Interface**: select the right interface type from the options provided. The device can automatically search the signal and starts to encode. **Resolution**: signal source resolution, read-only. **Video Bit rate**: adjust in range of 1.000~19.000 Mbps. **Video Format**: this unit supports mpeg2 and h.264 video encoding format in CBR/VBR bitrate control mode. User can also adjust values of rest items (Brightness & Contrast & Saturation: 0-255; Hue: -128 - +127)

5) Audio Bit rate: Select audio bit rate among 64, 96, 128, 192, 256, 320, 384 kbps.

Audio Format: Select audio format among MPEG2, MPEG2-AAC and MPEG4-AAC.

6) Program Information: User can enable or disable the program output under menu *Program Output*. User can also enter the other items to edit the *Service Name*, *Program Name*, *Program Number*, and PIDs of *PMT*, *PCR*, *Video* and *Audio*, and edit LCN (Logical channel number). *EIT Event* – User can enter this menu to setup EIT (Event Information Table) for the current and next program event. The EIT contains Start Year, Start Time, Duration, and Event Name of the event. All the EIT information can be displayed on the TV screen on condition that the EIT is chosen to insert (see explanation 18.). *VCN* – User can enter its submenus to setup the VCN (Virtual Channel Number) information.

7) Standard: Used for selecting the modulating standard. This unit contains 3 modulating standards – J.83A (DVB-C), J.83B and J.83C.

8) Constellation: DVB-C modulator contains 3 modulating standards. Different standard involves different modulating constellations. See the specification table for details.

9) Symbol Rate: adjust the symbol rate at the range of 5000-9000 Ksps.

10) RF Frequency: Adjust it at range of 30 to 999 MHz. Set it according your regional situation or inquire your local service.

11) RF Level: Adjust it at range of -16~ -36dBm.



H-AC3-CMOD-QAM-LL

12) RF On: User can choose to turn on or turn off the RF under this menu.

13) Bit Rate: User can read the current modulating bit rate and the maximum bit rate

14) TSID: (Transport Stream ID) User can view or adjust after enter this menu.

15) ONID: (Original Network ID)-User can view or adjust after enter this menu.

16) NIT: (Network Information Table)NIT table is a very important table for describing the network and TS.User can enter the submenus displayed and edit the values or select the LCN (Logical channel number) mode, and choose whether to insert the NIT. If user chooses to insert the NIT, information (Network ID, Network Name, LCN Mode, Private Data and LCN number of the program mentioned in explanation 6) will be added to the transport stream.

➤ **NOTE:** when the Private Data is set as 0*0, it is invalid.

17) VCT: Virtual Channel Table. This menu contains two sub-menus, Modulation Mode and VCT Insert. User can edit modulation mode at the range of 0-255. Choose to insert the VCT when J.83B is applied as the modulation standard.

18) EIT: EIT Insert - As mentioned above (6), the event information table can be chosen whether to insert into the TS or not under this menu. If yes, the EIT information set above (6) will be displayed on the TV screen. Language Code – to set the EIT language For example, code of the English language is *eng*. If you set the code as *eng*, the EIT displayed will be in English language.

19)-23) Please refer to *Chapter 4* for details.

24) Save Config: *Yes/No*-to save/give up the adjustment of setting.

25) Load Saved CFG: *Yes/No*-to load/ not to load the saved configuration.

26)Factory Reset: *Yes/No*-choose/not choose the factory's default configuration.

27) LCDTime out: A time limit that LCD will light off. Choose among 5s, 10s, 45s, 60s, 90s and 120s (seconds).

28) Key Password: to set a 6-digit password for unlocking the keyboard.

29) Lock Keyboard: Choose *Yes* to lock the keyboard, then the keyboard will be locked and cannot be applicable. It is required to input the password to unlock the key board. This operation is one-off. (Password forgotten, please use the universal code“005599”.)

30) Product ID: User can view the serial number of this device. It is read-only and unique

31) Version: It displays the version information of this device. *Encoder Modulator*: the name of the device; *SW*: software version number; *HW*: hardware version number. User can also press ENTER again to view the published time of this device.

Chapter 4

Record TS and Play TS through USB Disk

The H-VQAM-HD encoder modulator can play video/audio off a usb disk

1. *.ts Video Creation

2. TS Record and Save

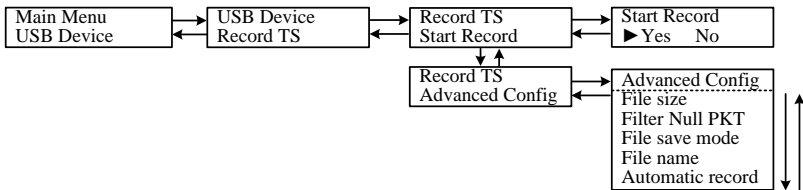

1) Connect the signal source, enter “Start Record” and choose “Yes” to start recording the encoded TS.

2) Advanced Config:

File size: users can set the file size for the *.ts to be recorded. A single file can be maximum 2000Mb in size.

Filter null PKT: Users can decide whether to filter the null packet for the *.ts files to be recorded.

File save mode: there are 3 modes provided: “single file” (For example, when the file size is set as 1000M and the *.ts is recorded up to 1000M, it automatically stops recording TS.). “Segmented file” (For example, when the file size is set as 1000M and the *.ts is recorded up to 1000M, it automatically saves the files and continues to record TS and save it to next file until the USB memory is full.) . “Loop record”: (it automatically saves the files and continues to record TS and save it to next file. When the USB

memory is full, it replaces the previous files.)

File name: Users can enter this menu to edit name for the *.ts files to be recorded. For example, if users name it "Record-", it will give name to the saved *.ts files "Record-001.ts", "Record-002.ts"... "Record-00N.ts".

Automatic Record: Users can choose whether to set Encoder record the TS automatically or manually.

3. TS Playback

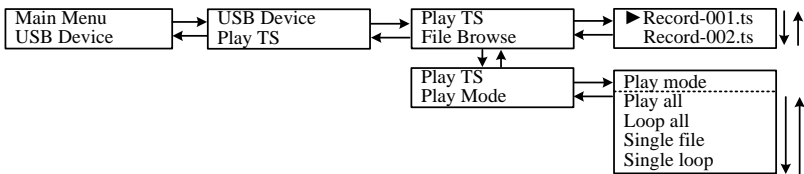

- 1) File browse: There is a video list under this menu, choose one file and press "Enter" button to start play.
- 2) Play mode: User can select a play mode for the saved *.ts files as needed before playing the *.ts file.

When the *.ts is being playing, Encoder LCD will present a playing interface as shown below.

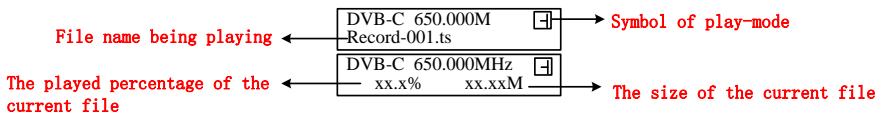

[] single loop; A play all; [A] loop all; 1 single file

At this time, the key board also plays a different rule

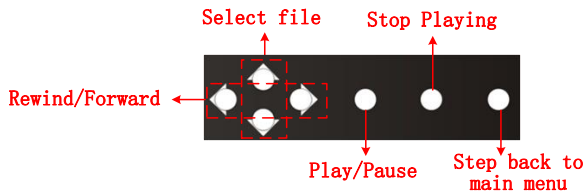

4. Disk Usage

THOR

H-AC3-CMOD-QAM-LL

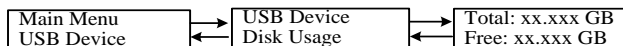

Users can enter this menu to view the USB disk's capacity left.

5. Update

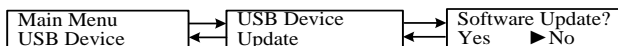

Choose "Yes" to update the Encoder with the update file stored in the USB disk.

6. Remove Device

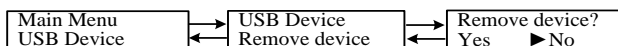

Choose "Yes" to safely remove the USB disk. Encoder will then automatically resume encoding and playing the program input from the encoder module.

Appendix

Air Channels			
Ch.	Frequency		
	Start	Center	End
VHF			
C00	45	48.5	52
C01	56	59.5	63
C02	63	66.5	70
C03	85	88.5	92
C04	94	97.5	101
C05	101	104.5	108
C5A	137	140.5	144
C06	174	177.5	181
C07	181	184.5	188
C08	188	191.5	195
C09	195	198.5	202
C9A	202	205.5	209
C10	209	212.5	216
C11	216	219.5	223
C12	223	226.5	230
UHF			
C20	470	473.5	477
C21	477	480.5	484
C22	484	487.5	491
C23	491	494.5	498
C24	498	501.5	505
C25	505	508.5	512
C26	512	515.5	519
C27	519	522.5	526
C28	526	529.5	533
C29	533	536.5	540
C30	540	543.5	547
C31	547	550.5	554
C32	554	557.5	561
C33	561	564.5	568
C34	568	571.5	575
C35	575	578.5	582
C36	582	585.5	589
C37	589	592.5	596

Air Channels			
Ch.	Frequency		
	Start	Center	End
C38	596	599.5	603
C39	603	606.5	610
C40	610	613.5	617
C41	617	620.5	624
C42	624	627.5	631
C43	631	634.5	638
C44	638	641.5	645
C45	645	648.5	652
C46	652	655.5	659
C47	659	662.5	666
C48	666	669.5	673
C49	673	676.5	680
C50	680	683.5	687
C51	687	690.5	694
C52	694	697.5	701
C53	701	704.5	708
C54	708	711.5	715
C55	715	718.5	722
C56	722	725.5	729
C57	729	732.5	736
C58	736	739.5	743
C59	743	746.5	750
C60	750	753.5	757
C61	757	760.5	764
C62	764	767.5	771
C63	771	774.5	778
C64	778	781.5	785
C65	785	788.5	792
C66	792	795.5	799
C67	799	802.5	806
C68	806	809.5	813
C69	813	816.5	820
C70	820	823.5	827
C71	827	830.5	834
C72	834	837.5	841
C73	841	844.5	848
C74	848	851.5	855
C75	855	858.5	862

Television Frequency/Channels (MHz)

Modulation Constellation	FEC	6MHz Bandwidth				7MHz Bandwidth				8MHz Bandwidth				
		Guard Interval				Guard Interval				Guard Interval				
		1/4	1/8	1/16	1/32	1/4	1/8	1/16	1/32	1/4	1/8	1/16	1/32	
QPSK	1/2	The weak ability of error-correcting and anti-interference in this area											6.03	
	2/3					6.03	5.80	6.45	6.83	7.03	6.64	7.37	7.81	8.04
	3/4			6.22	6.58	6.78	6.53	7.25	7.68	7.91	7.46	8.29	8.78	9.05
	5/6	6.22	6.91	7.31	7.54	7.25	8.06	8.53	8.79	8.29	9.22	9.76	10.05	
	7/8	6.53	7.25	7.68	7.91	7.62	8.46	8.96	9.23	8.71	9.68	10.25	10.56	
16QAM	1/2	7.46	8.29	8.78	9.04	8.70	9.67	10.24	10.55	9.95	11.06	11.71	12.06	
	2/3	9.95	11.05	11.70	12.06	11.61	12.90	13.66	14.07	13.27	14.75	15.61	16.09	
	3/4	11.19	12.44	13.17	13.57	13.06	14.51	15.36	15.83	14.93	16.59	17.56	18.10	
	5/6	12.44	13.82	14.63	15.08	14.51	16.12	17.07	17.59	16.59	18.43	19.52	20.11	
	7/8	13.06	14.51	15.36	15.83	15.24	16.93	17.93	18.47	17.42	19.35	20.49	21.11	
64QAM	1/2	11.19	12.44	13.17	13.57	13.06	14.51	15.36	15.83	14.93	16.59	17.56	18.10	
	2/3	14.92	16.58	17.56	18.09	17.41	19.35	20.49	21.11	19.91	22.12	23.42	24.13	
	3/4	16.79	18.66	19.76	20.35	19.59	21.77	23.05	23.75	22.39	24.88	26.35	27.14	
	5/6	18.66	20.73	21.95	22.62	21.77	24.19	25.61	26.39	24.88	27.65	29.27	30.16	
	7/8	19.59	21.77	23.05	23.75	22.86	25.40	26.89	27.71	26.13	29.03	30.74	31.67	